

Network Board

POA-MD13NET

OWNER'S MANUAL

INSTALLATION and OPERATION of the Network Board

This Network Board is an optional product to control and set up a projector via a network. Mount this product to the projector and connect a network cable. By accessing the connected projector using the web browser on your computer, the projector can be controlled and set up remotely.

This product is only used for our projectors that have a terminal for the Network Board. This manual explains the installation of the Network Board and its operation.

Preparation

Installation

Basic Setting and Operation

Controlling the Projector

Controlling the Multi-Projectors

Use of Serial Port

Appendix

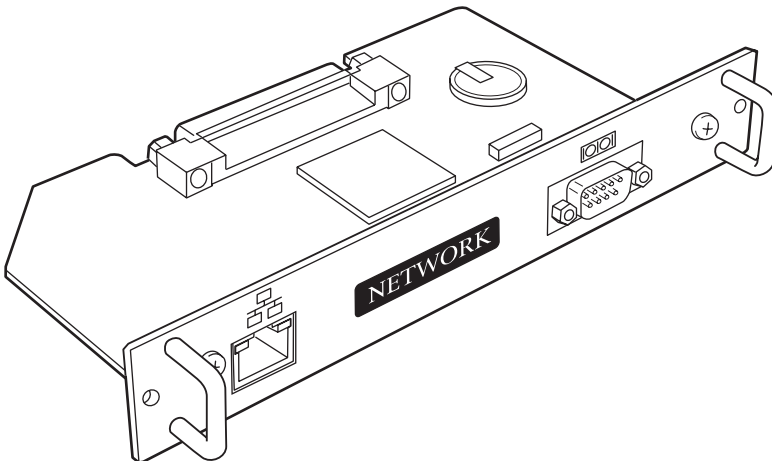

Compliances

Federal Communication Commission Notice

This equipment has been tested and found to comply with the limits for a Class A digital device, pursuant to Part 15 of FCC Rules. These limits are designed to provide reasonable protection against harmful interference when the equipment is operated in a commercial environment. This equipment generates, uses, and can radiate radio frequency energy and, if not installed and used in accordance with the instruction manual, may cause harmful interference to radio communications. Operation of this equipment in a residential area is likely to cause harmful interference in which case the user will be required to correct the interference at his own expense.

Do not make any changes or modifications to the equipment unless otherwise specified in the instructions. If such changes or modifications should be made, you could be required to stop operation of the equipment.

Warning

This is a Class A product. In a domestic environment this product may cause radio interference in which cause the user may be required to take adequate measures.

Trademark

Ethernet is a registered trademark of Xerox Corporation. Microsoft, Windows, Windows NT are registered trademarks of Microsoft Corporation. Macintosh, Mac OS are registered trademarks of Apple Computer Inc. Internet Explorer is a registered trademark of Microsoft Corporation. Netscape Navigator and Netscape Communicator are trademarks or registered trademarks of Netscape Communications Corporation. JavaScript is a registered trademark of Sun Microsystems, Inc.

Other product or brand names in this manual are registered trademarks or trademarks of their respective owners.

* Unauthorized use of a part or whole of the contents in this manual is prohibited.

* The contents of this manual are subject to change without notice.



Expression/Abbreviation

The following abbreviations may appear in this manual:

- Windows 95, Windows 98, Windows 2000,
Windows Me, Windows XP, Windows NT4.0 → Windows
- Macintosh, Power Macintosh → Macintosh
- Mac OS 8 or later → Mac OS

The word “projector” found in this manual means “projector provided with Network Board” unless otherwise noted.

Use of this manual

This manual does not provide the description of basic operation and functions for computer, web browser, projector and network. For instructions about each piece of equipment or application software, please refer to the respective booklet.



CAUTION ON USE IN NETWORK

- When you receive an alert e-mail from the projector, you must check the projector immediately. Fire or accident may result if the projector is used in an abnormal condition.
- When you install the projector at remote location and use it through the network, you must perform the safety inspections periodically. In this case you must pay attention to the change of environment in which you installed the projector. It may cause fire or an accident depending on the change of environment.

CAUTION

We assume no responsibility for the loss or damage of data or damage of the computer caused by use of this product.

Contents

Features	6
Operating Environment	8
Installation	9
Flow of installation	10
Name and function of each part	11
[1] Mounting	12
[2] Connection of LAN cable	13
[3] Confirmation of network menu activity	14
[4] Network configuration	15
Configure the network with the projector	16
Configure the network with the computer	18
Configure the network of computer	20
Windows 98/95/Me	20
Windows 2000/NT4.0	21
Windows XP	22
Macintosh	23
Notice about system construction	24
Basic Setting and Operation	25
Login the setting page of the projector	26
1 Enter the IP address	26
2 Select a display mode and login	26
3 Display of main setting page	27
Initial Settings	29
1 Language Setting	29
2 Password Setting	30
3 Date/Time Setting	30
Network Configuration	31
1 Configure the network	31
2 Name the projector	31
E-mail Setting	32
Examples: Type and contents of alert mail	34
Controlling the Projector	35
Power on/off the projector	36
Check the status of projector	37
Control the projector	38
Input	38
PC Adjustment	39
Load a Set	40
Save a Set	40

System Adjustment	.41
Image Adjustment	.42
Save a image adjustment value	.43
Load a image mode	.43
Sound Adjustment	.44
Screen Adjustment	.44
Setting	.45
About Lamp Counter reset	.46
How to set the Timer	.47
Check the Timer events	.47
Cancel the timer	.48
Service	.49
Save Actual Adjustment	.50
Check the Save items	.51
Control the projector's menu	.53
Make a memo	.54
Controlling the Multi-Projectors	.55
Multi-Control	.56
Register IP address and projector name	.57
Check IP address and projector name	.57
Exclude/Add/Delete a projector	.58
Control	.59
Load and apply the setting value	.59
Use of Serial Port	.61
Serial Port setting	.62
Control Examples	.64
Use of Telnet	.66
Control the projector with Telnet	.68
Appendix:A	.69
Examples of Connection	.70
Web browser setting	.72
Setting examples: OS/Browsers	.73
Product specification	.81
Port Specification	.82
Appendix:B	.83
FAQ	.84

Features

Web Management function

With this function, you can monitor projector functions such as power status, lamp status, input mode, signal condition, lamp-use time, etc. through the network by using the web browser installed on your computer.

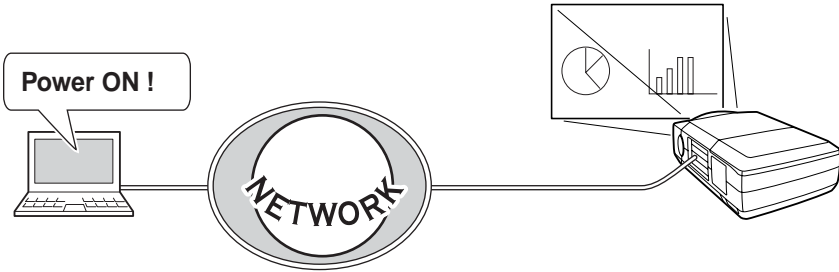

E-Mail Alert function

Projector (Network Board) sends messages to the registered e-mail addresses when a lamp abnormality or power failure occurs with the projector. In this message, it describes how to solve the cause of the problems. You can take efficient action for quick recovery.

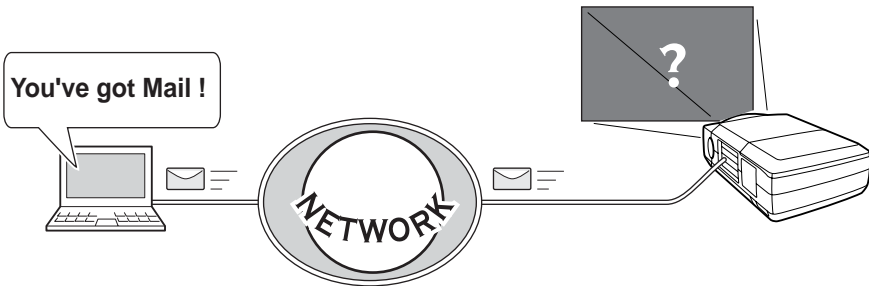

Multi-control function

A single computer can control and set up the multiple computers at the same time.

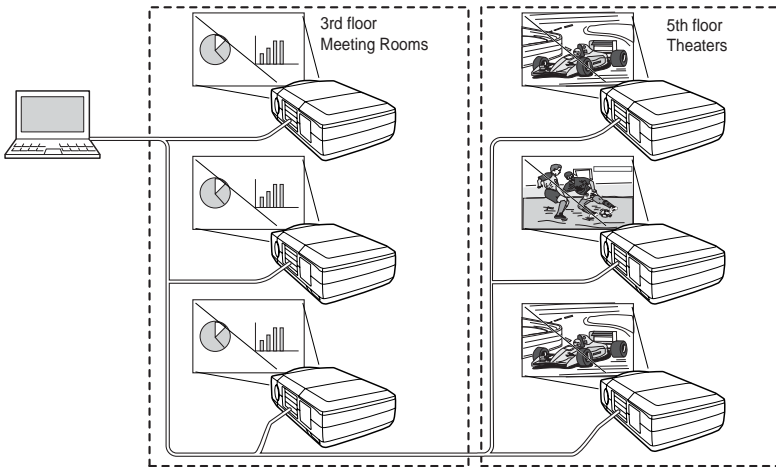

Automatic On/Off using Timer function

Automatically turn on or off the projectors at specified date/day and time by using the clock function.

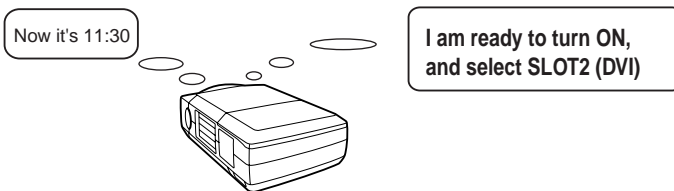

Control port ready for external equipment via network

This product provides a serial port (RS-232C) for controlling external equipment. By connecting the equipment which has a serial port, it can be controlled by a computer via the network. * This product does not provide the interface driver software to control external equipment.

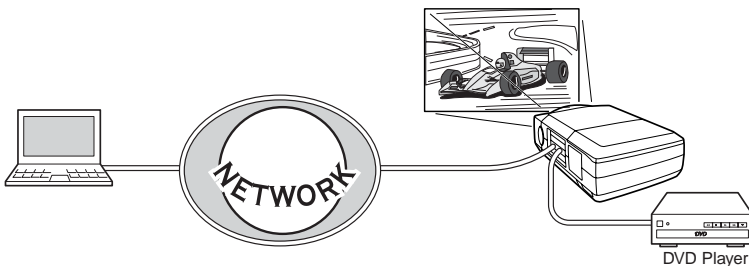

Operating Environment

To perform the management and setting up the projector using this product, the environment described below is required.

Operating System

Windows 95 / Windows 98 / Windows 2000 / Windows Me / Windows NT /
Windows XP
Mac OS 8.0 or later

Network

Network must handle Ethernet correctly and accept TCP/IP protocol.

Computer

The computer must provide a 10Base-T or 100Base-TX network card.

Web browser application*

- Microsoft Internet Explorer version 5.0 or later
- Netscape Navigator version 4.7 or later

* Use to control and set up the projector. The layout of pages in the browser may slightly differ from each type of application or operating system you use.

Internet mail application*

- Microsoft Outlook
- Microsoft OutlookExpress
- Netscape Mail

* Required the internet e-mail application software to receive an e-mail alert sent from this product. If you do not use the function E-mail Alert, this application is not required.

The limitation*¹ of connection between this product and Hub or Computer

Suitable LAN cables are limited by length and type as follows;

Connection	Type of usable LAN cable	Maximum length
Network Board - Hub	UTP Straight Cable with category 3 or 5 * ²	100m
Network Board - Computer	UTP Cross Cable with category 3 or 5* ²	100m

*¹ There may be other limitations depending on your network environment or LAN specification. Please consult your network administrator for further details.

*² Category of LAN cable indicates the cable quality. Normally, cable with category 3 or 5 is used for 10Base-T network and cable with category 5 is used for 100Base-TX network.

Installation

1

ENGLISH

Installation

Flow of installation

The following are instructions for attaching this product to the projector and connecting it to the network. Please review the entire procedure to become familiar with it.

1 Check package (p.11)

Please check the contents of a package. This product contains a network board, an owner's manual (this manual), a ferrite core and 2 screws. Also please check the name and function of each part.

2 Installation (p.12-14)

1. Mount this product to the projector.
2. Connect the LAN cable and join it to the network.
3. Confirm that the network menus are activated on the setting menu of the projector.

3 Network configuration (p.15-24)

Configure the network of the projector. Separate configurations must be set up for each network to which the projector will be connected.

- ☛ Configure the network with the projector.
- ☛ Configure the network with the computer.

Setting up is completed.

The preparation is completed to control the projector connected to the network. At next step, set up and control the projector via the network by using the web browser installed on your computer. Please see chapter "2: Basic setting and operation" on page 25.

Name and function of each part

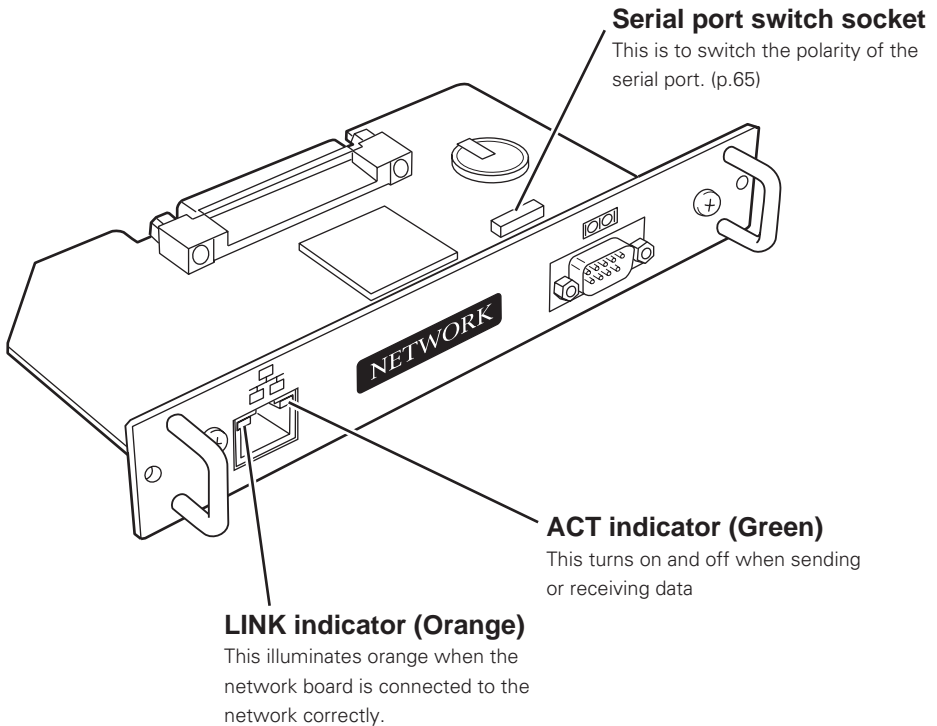

LAN port
Connecting the LAN cable.
(p.13)

Serial port
This is used when controlling the external equipment via the network. (p.61)



Do not touch the connector. It may damage the product.

(1) Mounting

1 Turn the Mains switch off.

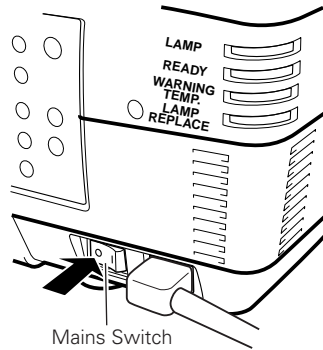

2 Remove 2 screws on a board from any of the slots 1 to 4*, and then pull the board out from the projector.

* The number of the slots may differ from the actual depending on type of the projector.

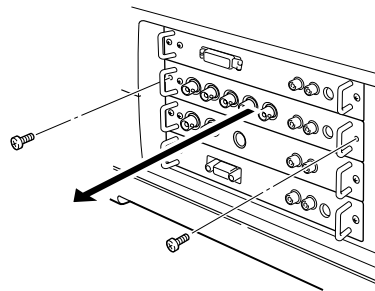

3 Put the Board into the board slot along the guide. Mount the board connector into the socket in the slot firmly.

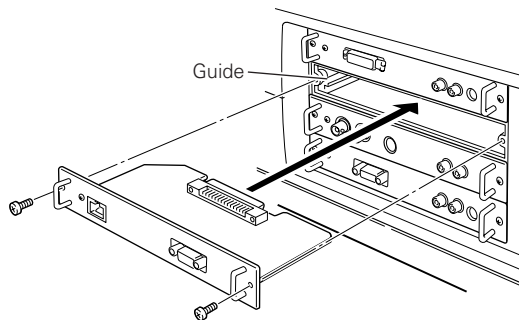

4 Secure the board with two screws (supplied).

* Mounting example of the 4 slots model.

Caution

- ✓ Mains switch must be turned off when mounting or removing this product otherwise it may damage the product.
- ✓ Do not install multiple network boards into a projector otherwise it may damage the product.
- ✓ Do not connect the AC cord until after connecting the LAN cable and computer.

(2) Connection of LAN cable

To connect to the network, it is required to use the UTP (Unshielded Twisted Pair) straight cable with RJ-45 plug. There are two different types of cables depending on whether the network is constructed with 10Base-T or 100Base-TX. Prepare the Hub (10Base-T or 100Base-TX) to distribute the network cable if required.

- 1 Turn the Mains switch off.
- 2 Wind the UTP straight cable once around the ferrite core (supplied) as the illustrated below.

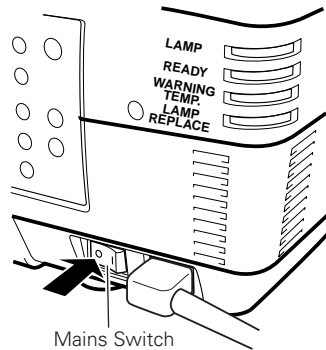
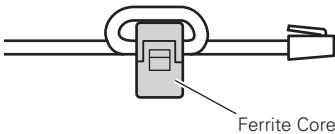

- 3 Connect the UTP straight cable to the LAN port on the network board.
- 4 Connect the UTP straight cable to the hub.

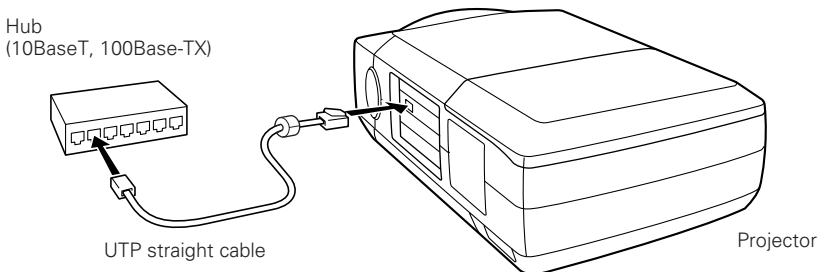

- ✓ Use the UTP cross cable when you connect the computer and projector directly not using the hub.
- ✓ When you connect the projector into the 10Base-T network, use cable with category 3 or 5. When you connect the projector into the 100Base-TX network, use cable with category 5.
- ✓ The length of cable between hub and projector should be less than 100m.

(3) Confirmation of network menu activity

When installing this product to the projector, the network on-screen menu items for this product are activated automatically. If not activated, the product may not have been installed correctly. Please check chapter “Mounting” on page 12.

Turn on the projector and display the menu on the screen.

Confirmation of network setting menu (Network)

Using the pointers on the remote control handset or on the projector, select the **Network** icon from the **Setting** sub menu, and then press the **SELECT** button once. Check if the setting is **On**. If not, switch to **On** by using the pointer **◀/▶**. The power indicator on this product will illuminate red.

Press the **SELECT** button again, the network setting menu appears on the screen as follows. For further information about network setting, please see chapter “Network configuration” on the next page.

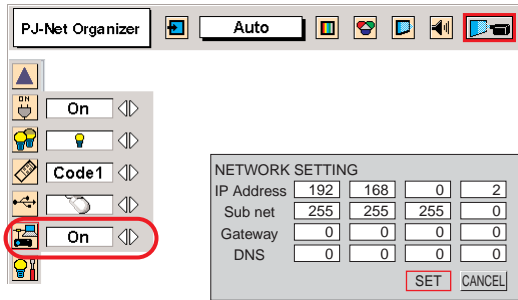

* The above on-screen display may differ from the actual display depending on the functions of the projector you use.

Confirmation of password setting menu (Display)

Using the pointers on the remote control handset or on the projector, select the **Display** icon from the **Setting** sub menu, and then press the **SELECT** button twice. The password setting menu appears on the screen. If not, please check if the function of Network is **On** as explained on previous item “Confirmation of network setting menu”. For further information about password setting, please see “Password setting menu” on page 17.

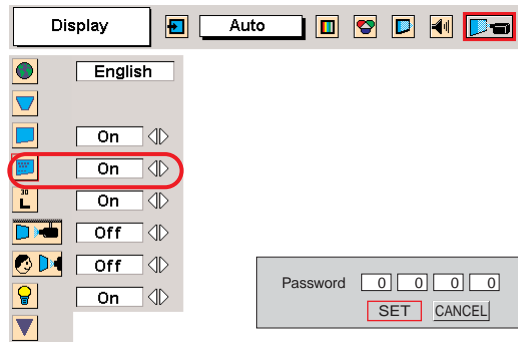

(4) Network configuration

When you connect a projector to a network, the network number of projector must be the same as the network you intend to connect. You should configure projector's network first. Make sure that the projector is connected to the network correctly. There are 2 ways to configure the network, by using the projector's menu **[A]**, or by using the computer **[B]**. Refer to the chart below and use the method you prefer.

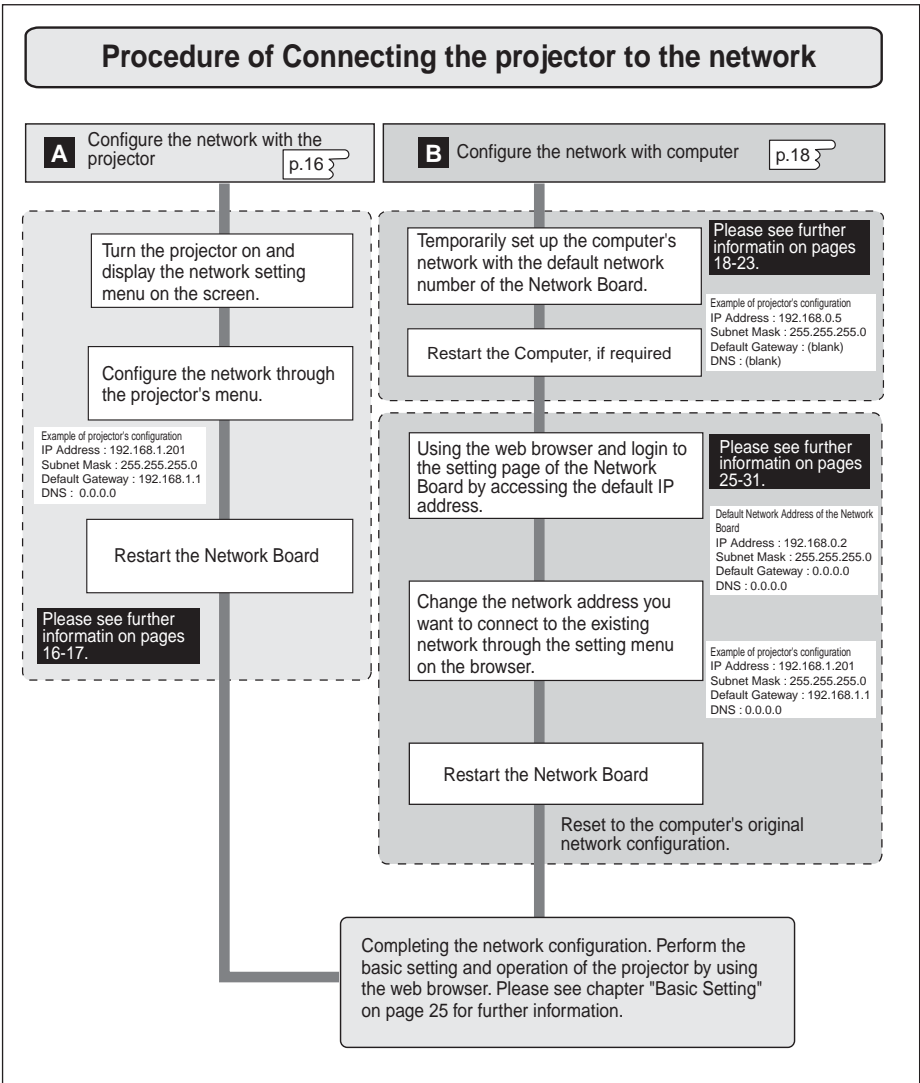

A Configure the network with the projector

This example explains how to set the following configuration.

IP Address	: 192.168.1.201
Subnet Mask	: 255.255.255.0
Default Gateway	: 192.168.1.1
DNS	: 0.0.0.0

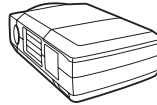

1 Selection of network menu [Network]

Turn on the projector and display the menu on the screen. Select the **Network** icon from the **Setting** sub menu using the pointers, and then press the **SELECT** button on the remote control or on the projector. Confirm that its mode is set **On**. If not, change mode to **On** using the pointer ◀/▶.

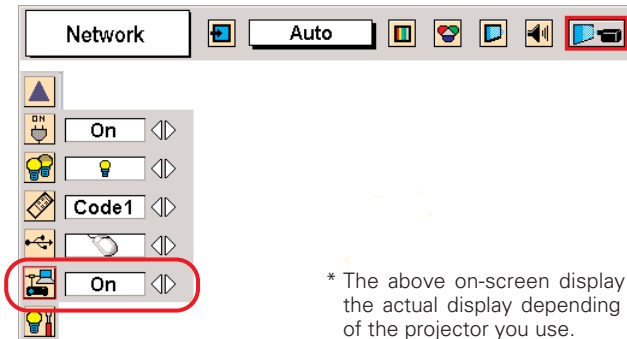

* The above on-screen display may differ from the actual display depending on the functions of the projector you use.

2 Configuration for IP Address/ Subnet mask/Default Gateway*/DNS*

Press the **SELECT** button again, the following network setting menu appears on the screen. Enter the specified network address with ▲/▼/◀/▶ keys. The following is an example of a network configuration.

NETWORK SETTING				
IP Address	192	168	1	201
Sub net	255	255	255	0
Gateway	192	168	1	1
DNS	0	0	0	0
			SET	CANCEL

* In the network environments not using a Gateway or Router, the Default Gateway address should be set to [0.0.0.0]. If you do not use the functions E-mail or DNS server, it should also be set to [0.0.0.0] for the DNS address.

How to enter the numbers

To move the selection and change the values, use the pointers ▲/▼/◀/▶ on the projector or on the remote control handset.

The ◀/▶ keys are used to move the selection item.

The ▲/▼ keys are used to change the number value.

3 Restart the Network board

Select the **SET** with ◀/▶ keys and press the **SELECT** button again. The network configuration display disappears and the network board begins restarting*1.

It takes about 60 seconds. Do not turn off the mains switch during this period.

Completing of installation

Now the installation is completed. The IP address of this projector was set to "192.200.1.201". Next, please see chapter "Basic setting and operation" on page 25. It describes basic setup and operation of the projector.

Password setting menu [Display]

A password can be set to restrict access to the setting pages of the projector using the web browser. The default password is set "0000" as no password.

Use the projector's menu and select the **Display** icon on the **Setting** sub menu, and then press the **SELECT** button on the projector twice. The following setting display appears on the screen. The numbers on the display indicate the current password. To change the password, enter your desired number by using the pointers on the projector or remote control handset, and then Select the **SET** with ◀/▶ keys and press the **SELECT** button. The password setting display disappears and the network board begins restarting*1. It takes about 60 seconds. Do not turn off the mains switch during this period.

Password

*1 The network board begins restarting automatically when the network configuration or password setting is changed and then the **SELECT** button is pressed.

- ✍ Password setting must be done when you connect the projector to the network. This setting is carried out through the projector's menu and also it can be set through the network using the web browser. For further information please refer to chapter "Initial Setting/Password setting" on page 30.
- ✍ Valid characters for password are 4 digits numeric numbers 0 to 9.
- ✍ This password is not to restrict the use of the projector. This password is to set the security against the use of the projector through the network.

B Configure the network with the computer

This example explains how to set the following configuration.

IP Address	: 192.168.1.201
Subnet Mask	: 255.255.255.0
Default Gateway	: 192.168.1.1
DNS	: 0.0.0.0

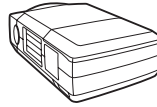

The default network configuration is set as follows.

IP Address	: 192.168.0.2
Subnet Mask	: 255.255.255.0
Default Gateway	: 0.0.0.0
DNS	: 0.0.0.0

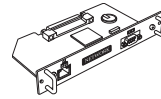

Make sure that the projector is connected to the network and then turn the projector on.

I Temporarily*¹ set up your computer network configuration to the same IP network number as the Network Board. For example, change your computer network configuration as follows and restart the computer.

IP Address	: 192.168.0.2
Subnet Mask	: 255.255.255.0
Default Gateway	: (blank)
DNS	: (blank)

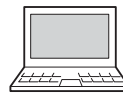

The network configuration of computer differs depending on each network environment or your computer. For further information, please see the next chapter "Configure the network of computer".

*1 Change your computer's network configuration temporarily. After completing the set up for the projector, you must set up again to the original network configuration for your computer. It is recommended to make a note of those network settings.

2 Configure the network of the projector by using the web browser.

1. Enter the IP address of the projector as the URL. The login page will be displayed and login. For further information, please see chapter “2: Basic Setting and Operation” on page 25.

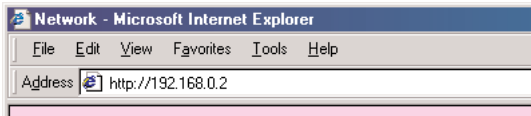

2. Configure the network through the setting page on the browser. For further information, please see chapter “Network Configuration” on page 31.

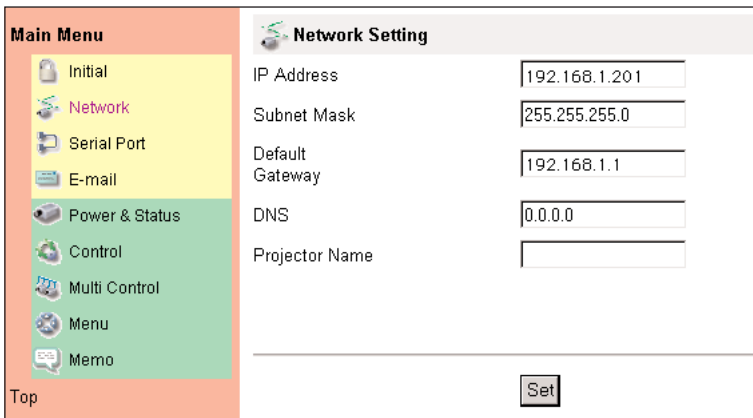

Completing of installation

Now the installation is completed. The IP address of this projector has been set to “192.168.1.201”. You must reset the network configuration of the computer to the original and restart the computer.

Next, please see chapter “Basic Setting and Operation” on page 25. It describes how to operate and set up the projector .

- ✂ If you use a cable to connect the projector and computer directly, without using a hub, you must use a UTP cross cable. In this case, you cannot access the login page if the setting of web browser is set to “Use proxy server”. It must be changed to the “Not use proxy server”. For further information, please see the “Web browser setting” on page 72.
- ✂ When you set up the network of projector which has a default setting by using the computer, it must be carried out in the network which does not provide any gateways (routers). If it has the gateways (routers), you must carry out the configuration by using the projector’s menu.



Configure the network of computer

When you use the projector through the network, the IP address of the projector must be the same IP network number of the existing network. Also it is required to use the same IP network number of the computer to set up the projector. In the network included with the gateway (router), it must be used with the IP network number specified by the gateway (router).

Configure the computer's network by following steps:

Windows 98/95/Me

This example explains how to set the following network address.

IP Address	: 192.168.0.5
Subnet Mask	: 255.255.255.0
Gateway Address	: 192.168.100.1

- 1 Select the **Control Panel** menu from [Start] - [Setting] menu.
- 2 Double click the **Network** icon on the control panel window.
- 3 Select the **TCP/IP***¹ item on the "Current Network Component" column on the "Network configuration" tab on the "Network" dialog window, and then press the **Properties** button.
- 4 Click the **IP Address** tab, and then select the **Specified IP address**. Enter the IP Address*² and Subnet Mask.
- 5 Click the **Gateway** tab and enter the Gateway Address then press the **Add** button. Please make sure that the entered gateway address appears on the "Installed Gateway" column.
 ✓ This setting is not needed if the network does not provide the gateway (router).
- 6 Click the **OK** button, the setting window will be closed and restart the computer.

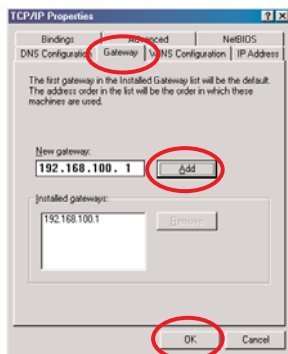
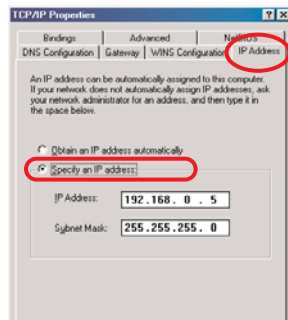
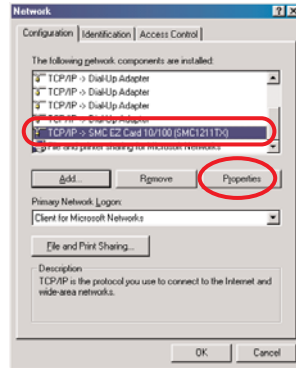

Windows 2000/NT4.0

This example explains how to set the following network address.

IP Address	: 192.168.0.5
Subnet Mask	: 255.255.255.0
Gateway Address	: 192.168.100.1

- 1 Select the **Network and Dial-up Connections** menu from [Start] - [Settings] menu.
- 2 Click the **Local Area Connection** icon with right button of the mouse and then select the **Properties** menu from the popup menu. The right window will appear on the screen.
- 3 Select the **Internet Protocol(TCP/IP)**¹ on the General tab of the "Local Area Connection Properties" dialog window and then press the **Properties** button.
- 4 On the "Internet Protocol (TCP/IP) Properties" dialog window, select the **Use the following IP address** button and then enter the IP Address*² and Subnet mask.
- 5 Enter the Default gateway address.
 ✓ This setting is not needed if the network does not provide the gateway (router).
- 6 Click the **OK** button, the setting window will be closed.

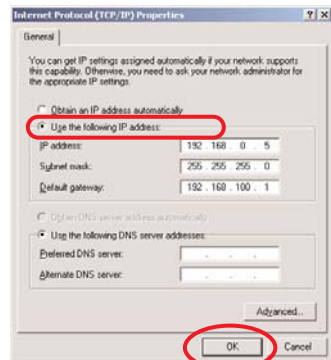
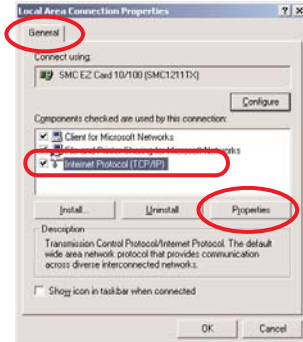

✓ To change the configuration, you may need administrator privileges.

- *1 Select the "TCP/IP" item of the LAN card you use. If the "TCP/IP" item is not listed in the column, you need to install the TCP/IP protocol. For further information refer to the user's manual of your computer.
- *2 If the network already has the TCP/IP protocol set, enter with the same IP network number for the IP address and Subnet mask.
- *3 There are some ways to set up the network depending on your computer's environment.

Windows XP

This example explains how to set the following network address.

IP Address	: 192.168.0.5
Subnet Mask	: 255.255.255.0
Gateway Address	: 192.168.100.1

- 1 Select the **Control Panel** menu from the [Start] menu. Click the **Network and Internet Connection** and then click the **Network** on the control panel.
- 2 Click the **Local Area Connection** icon with right button of the mouse and then select the **Property** menu. The right window will appear on the screen.
- 3 Select the **General** tab on the “Local Area Connection Properties” dialog window. Select the **Internet Protocol(TCP/IP)**^{*1} and then press the **Properties** button.
- 4 On the “Internet Protocol (TCP/IP) Properties” dialog window, select the **Use the following IP address** button and then enter the IP address^{*2} and Subnet mask.
- 5 Enter the Default gateway address.
 ✓ This setting is not needed if the network does not provide the gateway (router).
- 6 Click the **OK** button, the setting window will be closed.

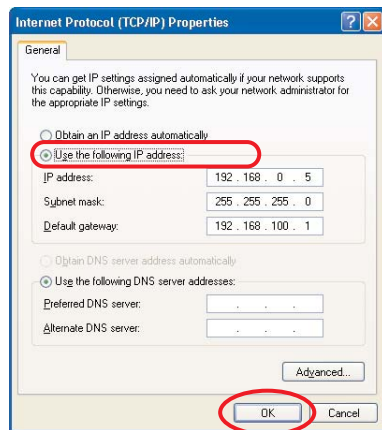
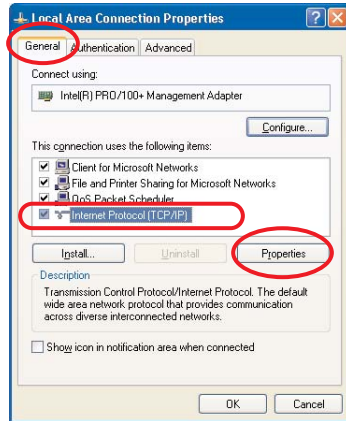

*1 Select the “TCP/IP” item of the LAN card you use. If the “TCP/IP” item is not listed in the column, you need to install the TCP/IP protocol. For further information refer to the user’s manual of your computer.

*2 If the network already has the TCP/IP protocol set, enter with the same IP network number for the IP address and Subnet mask.

*3 There are some ways to set up the network depending on your computer’s environment.

Macintosh

This example explains how to set the following network address.

IP Address	: 192.168.0.5
Subnet Mask	: 255.255.255.0
Gateway Address	: 192.168.100.1

- 1 Select **TCP/IP***¹ menu from the [Apple] - [Control Panel] menu.
- 2 Select **Ethernet** from the "Connect via" pull-down menu and **Manually** from the "Configure" pull-down menu of the TCP/IP Control Panel.
- 3 Enter the IP Address*² and Subnet Mask.
- 4 Enter the Router Address.
 - ✓ This setting is not needed if the network does not provide the gateway (router).
- 5 Close the setting window and save the setting.

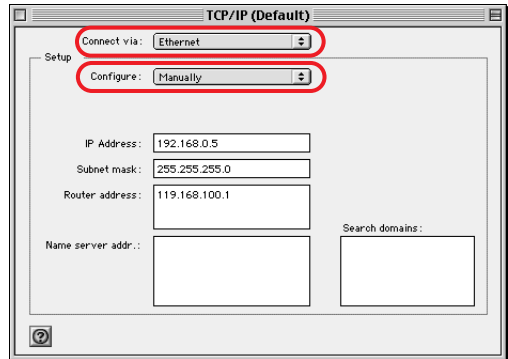

*1 Select the "TCP/IP" item of the LAN card you use. If the "TCP/IP" item is not listed in the column, you need to install the TCP/IP protocol. For further information refer to the user's manual of your computer.

*2 If the network already has the TCP/IP protocol set, enter with the same IP network number for the IP address and Subnet mask.

Notice about system construction

For installation of multiple projectors into the same network with Network Board.

Do not install multiple projectors with Network Boards that have their default network settings to the same network. The use of the Network Boards which have the default IP address set to the same network settings will cause IP addresses to collide and create a malfunction. When you install multiple projectors into the same network, configure the network with the following steps.

1. Change the IP address from the default IP address. To change the IP address, use the network setting menu on the projector. Please see chapter “Network Configuration” on page 15 for further information.
2. Make sure that there is no network equipment set with the same IP address in the network, and then connect to the network.
3. When installing other projectors, follow the above steps to change the IP address and connect to the network.

In case of installing the projector with Network Board into the network constructed with the DHCP/BOOTP server.

This Network Board does not support the DHCP/BOOTP server. The static IP address must be configured by the manual. To use this product in this network environment, set it up so that the DHCP/BOOTP server does not assign the IP address configured to this product for another device on the network. Please consult your network administrator for further information.

2

Basic Setting and Operation

Basic Setting and Operation

This chapter describes basic operations and settings for controlling the projector via a network using this product. It is required that computer and projector are connected to the network and the network address be properly configured.

Login the setting page of the projector

1 Enter the IP address

Launch the web browser installed in your computer, enter the IP address into the "Address" on the browser and the press the "Enter" key.

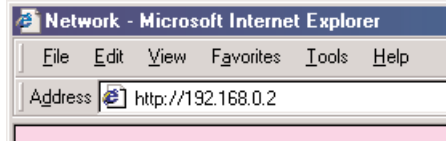

Enter the IP address that you configured in chapter "Network Configuration" on page 15. The default IP address is [192.168.0.2].

2 Select a display mode and login

This product provides 2 types of control mode, Graphic Mode and Text Mode as the below. Select a proper mode to match your PC and network environment by clicking on the text link.

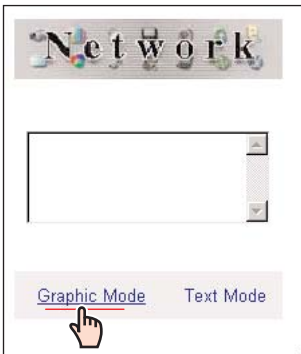

Graphic Mode

Displays with 600 x 400 dots and the menus and settings with graphic icons. This mode is recommended for standard use.

Text Mode

Displays with 200 x 300 dots. This mode is optimized for use of the handheld computer, PDA, etc. It is also convenient if the network traffic is heavy.

If the setting page has set the password, the authentication window will appear. In this case type "user" onto the **User Name** text area and the login password onto the **Password** text area and then press the **OK** button.

* The entering **User Name** must be "user" and it can not be changed.



[Note]
When accessing projector for the first time or setting the no password [0000], the auto-login will be performed and the next main setting page is displayed.

3 Display of main setting page

The following main setting page will be displayed according to your display mode selection. Perform the various kinds of setting through this page. Click on the linked text to display the control and setting pages.

1 Main setting page in the Graphic Mode display

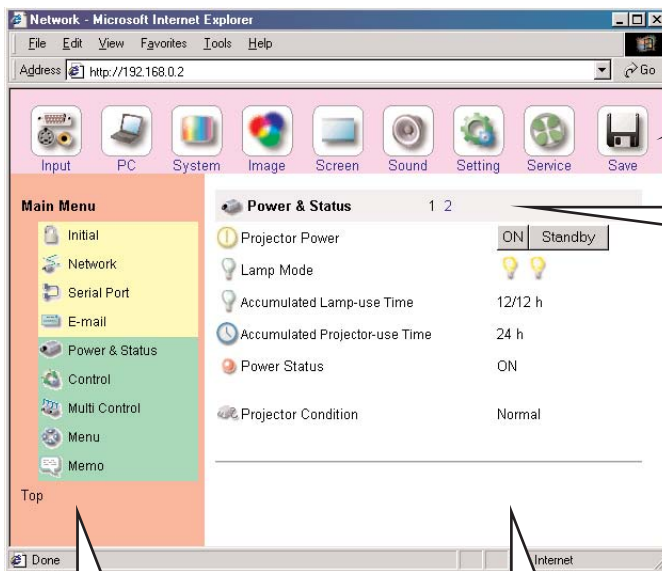

Control sub menu
For selection of sub menu to control and set the projector.

Setting page number
browses pages by clicking the linked number.

Main menu

For selection of control and setting items of the projector. It is described from page 35.

Setting page

Displays the control and setting items according to the selected menu. The "Power & Status" page is displayed as the default.

* This graphic mode display is mainly used through this manual for the setting and control description.

2 Main setting page in the Text Mode display

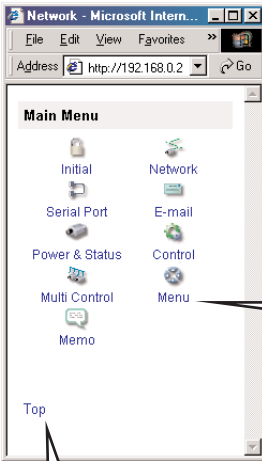

Main menu
For selection of control and setting items of the projector. Displays sub menu and status of selected items when clicking the linked text.

Returns to the display mode selection page.

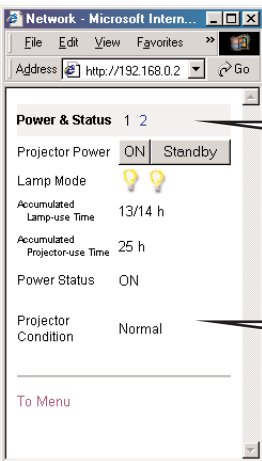

Setting page number
browses pages by clicking the linked number.

Setting page
Displays the control and setting items according to the selected menu.



Initial Settings

After installing this product to the projector, perform the following basic initial setting.

Click on the **Initial** linked text on the main menu to display the initial setting page. The Languages, Date/Time and Password can be set in this page. The model name of the projector on which this product is mounted is displayed on the page.

1 Language Setting

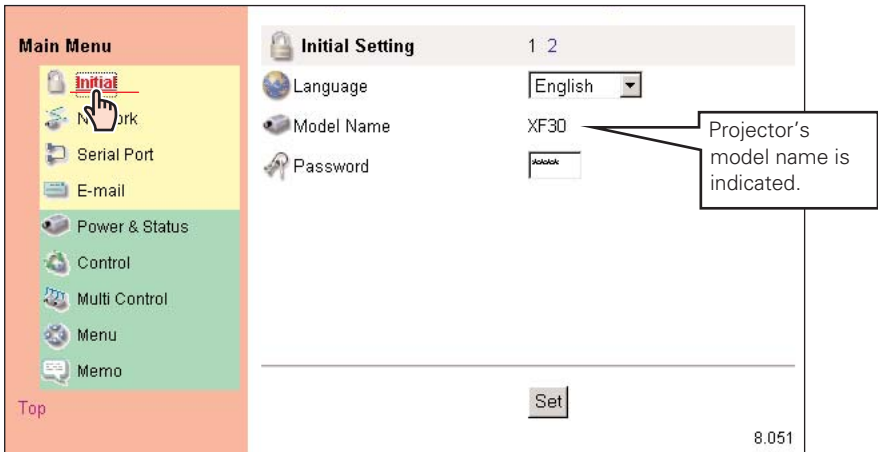

This setting is to select the display language of the web page. Select your language with the pull-down menu button and then press the **Set** button. The selectable language is English or Japanese. You may find the unrecognized character text in the menu if the computer does not provide Japanese fonts.

[Note]

This language selection is realized by using the JavaScript function of the web browser. If the preference of the browser is set not to use the JavaScript, the "Set" linked text appears on the page as the below. There are various kind of ways to change this preference depending on the web browser's version and application. Please refer to chapter "Appendix: Web browser setting/Active Script (JavaScript enable)" on page 72.

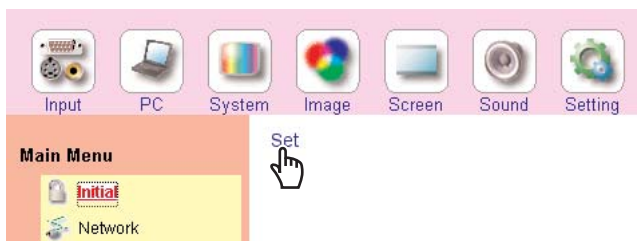

2 Password Setting

This page is to set the password to restrict the access from an unauthorized person through the network.

Enter the password onto the text box and press the **Set** button.



The Network Board begins restarting and it takes about 40 seconds. Close (Quit) the web browser and access to the login page again in 40 seconds. This is to perform the login authentication firmly.

The default password [0000] means no password. You should change password from the default in normal use. When you connect the projector with this product to the network, you should set a password. Only a four-digit numeric number is valid characters for the password.

* If you forget the password to the projector, you can check it by selecting the "Display" sub menu from the "Setting" menu on the projector. For further information, please see chapter "Password Setting" on page 17.

3 Date/Time Setting

Click on the page number "2" to display the Time Setting page.

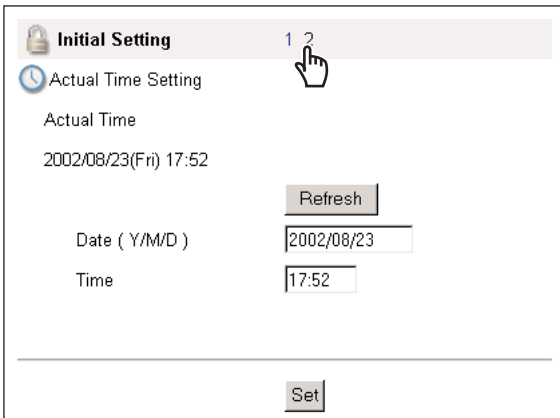

Type present date onto the date text area with (Year/Month/Date) format and type present time onto the time text area with (Hour:Minute) format in 24 hours indication. Press the **Set** button and confirm that the data and time are set correctly. The displayed date and time are not updated automatically, press the **Refresh** button to get the present date and time.

Caution

Use of Battery

This product provides a lithium battery. When the battery runs down, the clock and timer functions do not operate properly. Contact your local dealer for the replacement of battery. The replacement must be carried out by a qualified service personnel.



Network Configuration

Click on the **Network Setting** linked text on the main menu. The following setting page is displayed. This page is to set the IP Address, Subnet Mask, Default gateway, DNS (Domain Name Server) and projector name.

<p>Main Menu</p> <ul style="list-style-type: none"> Initial <li style="background-color: #ffffcc;">Network Set Port E-mail Power & Status Control Multi Control Menu Memo <p>Top</p>	<p>Network Setting</p> <p>IP Address <input type="text" value="192.168.1.201"/></p> <p>Subnet Mask <input type="text" value="255.255.255.0"/></p> <p>Default Gateway <input type="text" value="192.168.1.1"/></p> <p>DNS <input type="text" value="0.0.0.0"/></p> <p>Projector Name <input type="text"/></p> <p style="text-align: right;"><input type="button" value="Set"/></p>
--	--

1 Configure the network

The IP address and Subnet Mask have been configured already in chapter "Installation". If you want to change them or configure default gateway*¹ or DNS*², perform them in this page. Enter an applicable address number onto each parameter and press the **Set** button.

The Network Board begins restarting and it takes about 40 seconds. Close (Quit) the web browser and access to the login page again in 40 seconds.

- ✎ You must use the number specified by your administrator. The address must be entered as a group with four numbers split by dots like [192.168.1.101].

2 Name the projector

You can name*³ the projector. By setting this name properly for the DNS server, the projector can be accessed by using this name instead of the IP address.

For further information, please consult your network administrator.



*1 Set [0.0.0.0] if the network does not provide the gateway (router).

*2 Set [0.0.0.0] if you do not use the function E-Mail alert.

*3 If you use the DNS server, register the host name registered to the DNS server as a projector name. You can access with this projector name from any computers in your network. If you do not use the DNS server, access with the IP address assigned to the projector.



E-mail Setting

This product has an E-mail function which can send an alert message to users or an administrator if it detects an abnormality on the projector or run out of the life span of the lamp. Click on the **E-Mail Setting** linked text on the main menu and follow the below steps.

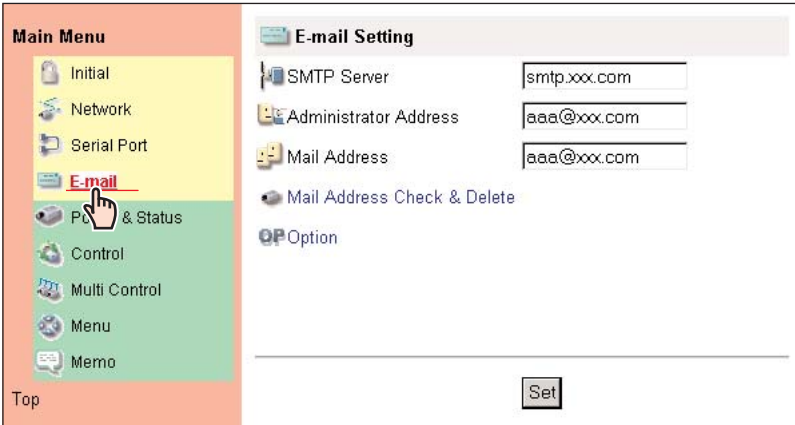

1 SMTP Server*1

Type the E-mail address of SMTP server and administrator and press the **Set** button. The administrator address is set to "Reply-To" address sent from the projector.

2 Registering and deleting E-mail addresses

Type the E-mail address onto the **Mail Address** text area and press the **Set** button. To check the registered addresses, click on the **Mail Address Check & Delete** linked text. The addresses are listed as the figure on the right.



To delete the registered addresses, check the address you want to delete and press the **Delete** button.

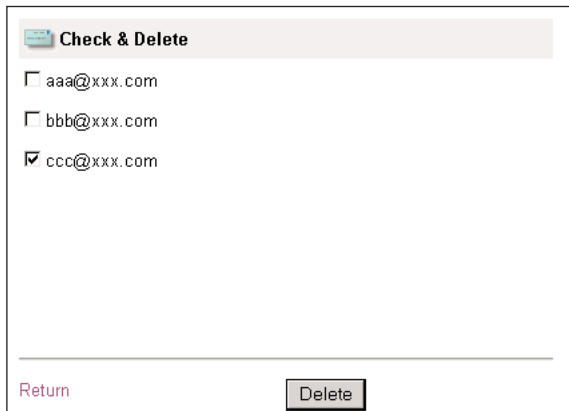

3 Condition selection for sending alert message

Click on the **Option** linked text. Check the condition items under which alert messages will be sent and press the **Set** button.



Please refer to chapter “Examples :Type and contents of alert messages” described on the next page.

 **Mail Option**

- When the projector lamp is off.
- When the life span of Lamp is reached.
- When internal projector power circuit is failed.
- When internal projector temperature is too high.
- When the projector is turned off with power ON/OFF button.
- When Power management function turns the projector lamp off.
- When the signal is interrupted.

Return
Set

*1 The SMTP server is a server for sending E-mail. Please contact your network administrator to have this SMTP server address.

- ✍ To use the E-mail function, it must be set the DNS address on the Network Setting page correctly.
- ✍ You cannot use this E-mail function if the DNS server and SMTP server cannot be used in your network environment. If the SMTP server is located in your LAN (Local Area network), the address set to SMTP server should be specified in the SMTP server located in your LAN. The server located outside of your LAN may not be available for security reason. For further information please contact your network administrator.
- ✍ Up to 10 e-mail addresses can be registered.

Examples: Type and contents of alert mail

When the projector has an abnormality, the following alert messages are sent to the registered E-mail address according to your selected condition. Administrator or user can take an efficient action quickly by receiving this message. This is very useful to maintain and service the projector.

The following are examples of received messages.

● When the internal temperature is too high:

TITLE: Message from projector
01-01-2001 00:59
Projector Model Name: XF30
TCP/IP: 192.168.0.2 Projector Name: myProjector

It sends you following message.

*The Projector lamp is turned off, because internal projector temperature is too high.

Wait Temperature Warning Indicator turned off, turn the Projector on again.
If the Indicator continues to flash, check the air filter for dust accumulation.

[A] 36.5 Degree [B] 58.2 Degree
Temperature of Sensor B is too high.

- ✍ The Network Board let users know which thermal sensor [A] or [B] inside the projector detected the abnormal rise in temperature and so the projector was turned off. Please refer to page 35 for the location of the sensors [A] and [B], and temperature. Also see the owner's manual of the projector for further details.

● When the internal power circuit is failed:

TITLE: Message from projector
01-01-2001 00:58
Projector Model Name: XF30
TCP/IP: 192.168.0.2 Projector Name: myProjector

It sends you following message.

*The Projector lamp was turned off, because projector power circuit failed.
Unplug the projector from AC outlet and ask servicing to qualified service personnel.
information : FFFFFFFFFF

- ✍ The Projector lamp was turned off, because the projector power circuit failed. Unplug the projector from AC outlet and ask servicing to a qualified service personnel with the information code "FFFFFFF".

● When the life span of lamp is reached:

TITLE: Message from projector
01-01-2001 00:58
Projector Model Name: XF30
TCP/IP: 192.068.0.2 Projector Name: myProjector

It sends you following message.

*The life span of lamp2 is reached.
Lamp2 replacement is required.
Lamp1 ON 350 h
Lamp2 ON 500 h
Lamp3 ON 60 h
Lamp4 ON 350h

- ✍ Replace it with a new lamp immediately and reset the lamp counter. If the projector is used without resetting the lamp counter, the alert mail is sent to users every time the projector is turned on. This alert mail will not be sent when unchecking the mail sending condition "When the life span of lamp is reached".

Controlling the Projector

3

ENGLISH

Controlling the Projector



Power on/off the projector

Click on the **Power & Status** linked text on the main menu. The control page will be displayed.

By Pressing the **On** or **Standby** button on the page, the power of the projector can be controlled. When you press the **Standby** button, another confirmation popup window*1 will appear, and then press the **OK** button if it is set to standby.

Power & Status	
Projector Power	ON Standby
Lamp Mode	Two lit light bulbs
Accumulated Lamp-use Time	12/12 h
Accumulated Projector-use Time	24 h
Power Status	ON
Projector Condition	Normal

[Note]

*1 This popup window is realized by using the JavaScript function of web browser. If the preference of the browser is set not to use JavaScript, the popup window will not appear on the screen.

There are various kind of ways to change this preference depending on the web browser's version and application. Please refer to chapter "Appendix: Web browser setting/Active Script (JavaScript enable)" on page 72.

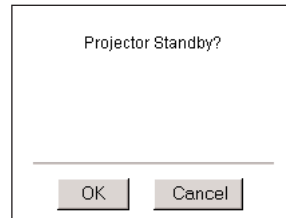
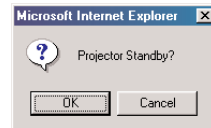

- ✓ The projector is not turned on for about 90 seconds after switching into the standby mode. After the power status indicator on the control page changes from "On Cooling down" to "OFF", then try to turn on the projector with **On** button.
- ✓ The web browser checks and updates projector's condition every 20 seconds automatically.

Check the status of projector

In the "Power & Status" page, you can control the projector power, and also you can check the status of the projector as follows. To change the page, click on the page number linked text.

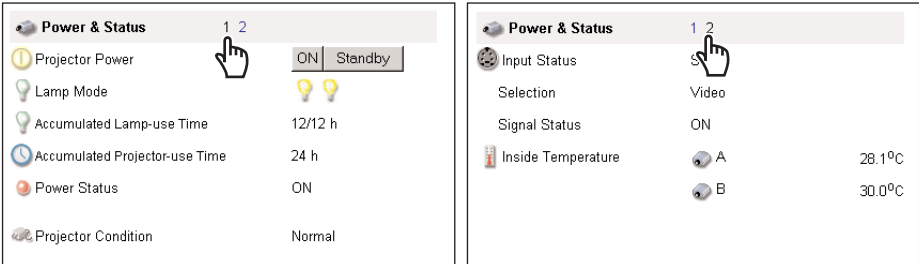

Items Description

Lamp ModeDisplays 2 lamps or 4 lamps mode and lamp status as below icons with Lamp1/Lamp2/Lamp3/Lamp4 order.

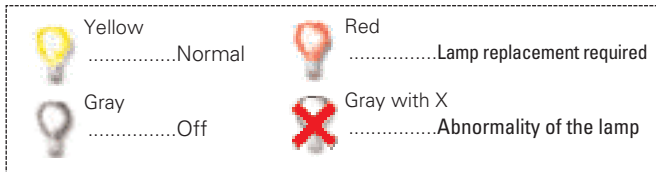

Accumulated

Lamp-use TimeDisplays the accumulated lamp use time in hour units (h) and displays each time with Lamp1/Lamp2/Lamp3/Lamp4 order.

Accumulated

Projector-use TimeDisplays the accumulated projector use time in hour unit (h).

Power StatusDisplays the status of the lamp.

Projector ConditionDisplays the status of the projector's power.

Input StatusDisplays the selected slot.

SelectionDisplays the selected input mode.

Signal StatusDisplays the signal status of the selected input mode.

Internal temperatureDisplays the temperature at internal thermal sensors in degrees. The icons [A] and [B] on the page represent the thermal sensors located in the projector. If the temperature at one of those sensors exceeds specified temperature, the appearance of its icon changes to the following alert icon to let users know about the abnormal temperature. Please check surrounding temperature of the projector, check for clogged air filters and check area surrounding the ventilation fans.



The icons [A] and [B] represent the sensors located in the projector as follows:

[A]: Surrounding temperature of the projector *

[B]: Internal temperature of the projector

* The indicated peripheral temperature of the projector is a little higher than actual surrounding temperature.

Control the projector

The control menus are displayed on the upper side of the page. When you click each control icon, the control page is displayed according to the control menu you selected. The setting method differs depending on the contents of the page. Click on the page number linked texts to change pages and select desired setting items.

✓ Please see the owner's manual of the projector to have the further information of each control item.



- ✓ The control page displays valid control items depending on the selected input mode, signal or functions of the projector you use, therefore, there may be different controls between the described items and actual control items on the page display.
- ✓ When the projector is in standby, only the timer on the setting menu is effective; others are inactive.



Input

This function is to select the input mode and slot to the projector. Select the input slot with the radio button, and input source mode with the pull-down menu button. Then set the selected input source and source mode by pressing the **Set** button.

Select a slot with radio buttons.

Select a source mode with pull-down menu.

Mounted Board name

To Menu Set

Item	Description
SLOT	Displays slot no. and board name installed in the projector. The setting items differ from the actual depending on the board function.



PC Adjustment

This function is to adjust the signal from the computer connected to the projector to obtain the proper picture image on the screen. Click on the page number linked texts to change the setting pages.

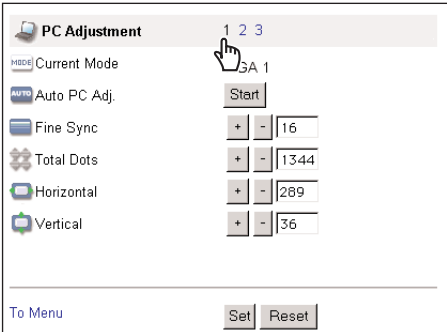

Item	Description
Current Mode	Displays current mode of the computer.
Auto PC Adj.	Performs automatic adjustment.
Fine Sync.....	Performs Fine Sync adjustment.
Total Dots	Adjust the number of total dots in the horizontal period.
Horizontal	Adjusts horizontal picture position.
Vertical	Adjusts vertical picture position.

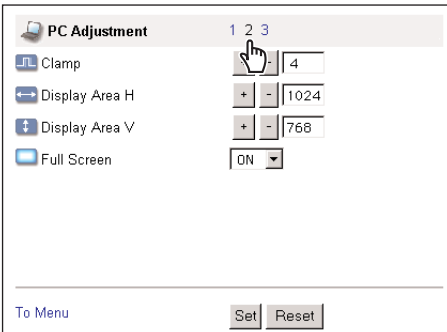

Item	Description
Clamp	Adjusts clamp position of the picture.
Display Area H	Adjusts the image area horizontally.
Display Area V	Adjusts the image area vertically.
Full Screen	Makes the image full screen display.

✎ These parameters will appear only when the analog computer input mode is selected.

Save a Set

- 1 Decide your desired PC adjustment values through the PC Adjustment pages "1" to "2".
- 2 Display the page "3" and select a mode number with the pull-down menu button of the **Save to**. Type a memo into the **Memo** text area for simple description of your selected number.

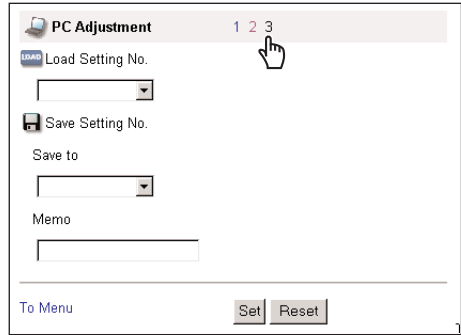

- 3 Register by pressing the **Set** button. To restore the adjustments, press the **Reset** button.

It is displayed with "Stored" or "Free" for the memo of Mode1 to Mode5. The memo of ExMode6 to ExMode50 can be stored into the selected mode.

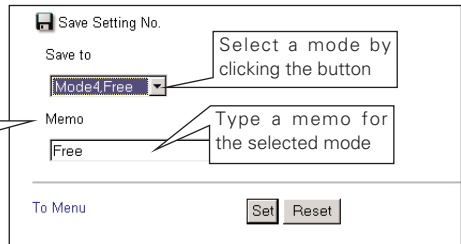

Load a Set

Select a set to load with the pull-down menu button of the **Load Set No.** and press the **Set** button. The stored setting values will be applied to the each PC adjustment item.

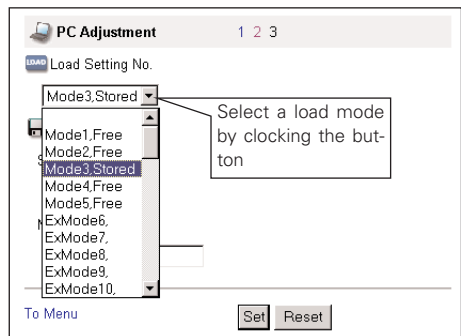

✓ The PC adjustment settings can be stored up to 50 sets, 5 sets for Mode1 to Mode5 and 45 sets for ExMode6 to ExMode50.



System Adjustment

This function is to select the color system of video signal or scanning system of component signal input to the projector. Select a system with the radio buttons to match the color system or scanning system of input source, and then press the **Set** button. The displayed systems are switched according to the input mode.

Available selection when the VIDEO/S-VIDEO input

Item	Description
Color SystemSelects a color system of the input video signal.
AUTOIt automatically switches to the color system of the input signal.

Available selection when the Y, Cb/Pb, Cr/Pr input

Item	Description
SystemSelects a scanning system of the input component signal.
AUTOIt automatically switches to the scanning system of the input signal.

✎ These selections will not appear when the source mode is set to the computer mode.



Image Adjustment

This function is to adjust the projected picture image and set the image mode. For selection of image mode, select a desired image mode with the

Image Adjustment Mode pull-down menu button and then press the **Set** button. The setting items are switched automatically according to selected input mode, computer or video input.

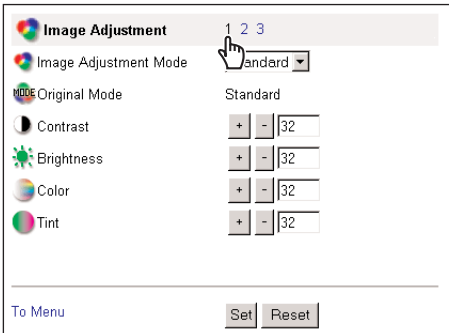

Item	Description
Image Adjustment.	...Selects image mode among the Standard, Real, Cinema, Image1 to Image4 with pull-down button menu . Image1 to 4 are user preset mode.
Original Mode	Displays which predefined image adjustment mode is based upon.
Adjustment items	Contrast, Brightness, Color, Tint

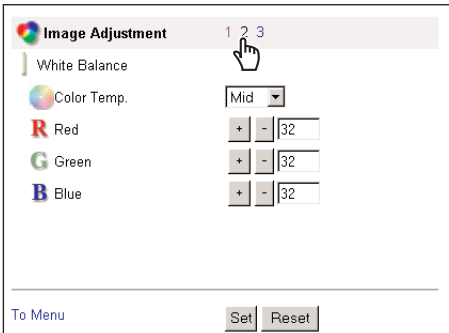

Item	Description
White Balance	
Color Temp.	Sets a color temperature mode.
Red, green,	
Blue	Adjusts a white balance respectively.

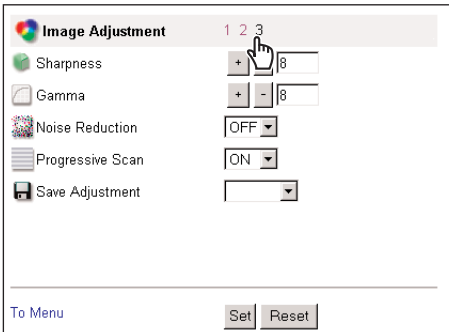

Item	Description
Sharpness.....	Adjusts picture sharpness.
Gamma	Adjusts brightness of darker part of the picture.
Noise Reduction	Switches noise reduction on/off.
Progressive	Switches progressive mode.
Save Adjustment	Select a mode to store the image adjustment values.

* The displayed adjustment items may differ from the actual depending on the functions of projector you use.

Save a image adjustment value

- 1 Decide your desired image adjustment value through the image adjustment pages "1" to "3".
- 2 Display the page "3" and select the desired image number with the pull-down menu of the **Save Adjustment**.
- 3 Register by pressing the **Set** button.
To restore the adjustments, press the **Reset** button.

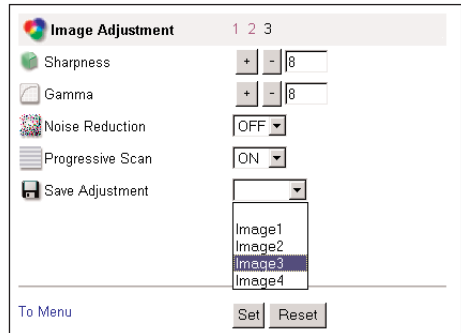

The **Image1** to **Image4** are for the user preset modes to store the image adjustment. The **Original Mode** is represented the mode that user preset mode **Image1** to **Image4** is created from the predefined image modes **Standard**, **Real** or **Cinema**.

Load a image mode

Display the page "1" and select a set to load with the pull-down menu button of the **Image Adjustment Mode** and press the **Set** button.

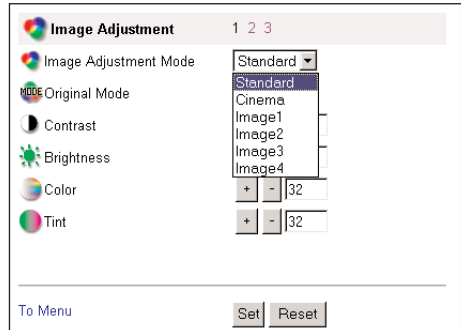



Screen Adjustment

This function is to adjust the screen mode of the projector. The setting items are switched automatically according to selected input mode, computer or video input.

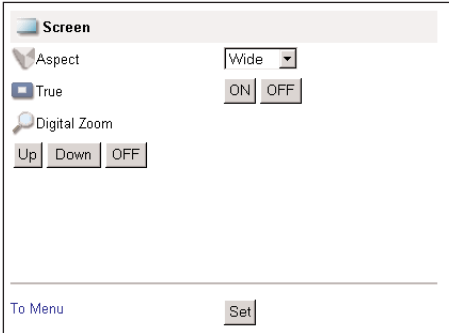

Item	Description
Aspect.....	Changes the screen mode.
True*	Switches the projected image mode.
Digital Zoom*	Adjusts the image zooming or compressing.

* These items are only available in the computer input mode.



Sound Adjustment

This function is to adjust the sound of the projector. The values in each text box represent the current control value or status.

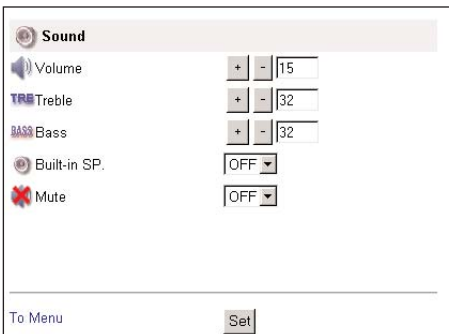

Item	Description
Volume	Adjusts the sound volume from the built-in speakers.
Treble	Adjusts the high-frequency sound band.
Bass	Adjusts the low-frequency sound band.
Built-in SP.....	Switches the sound output from the built-in speaker
Mute	Suppresses the sound.



Setting

This function is to set up the projector. Click on the page number “1” to “5” linked texts to change the setting pages.

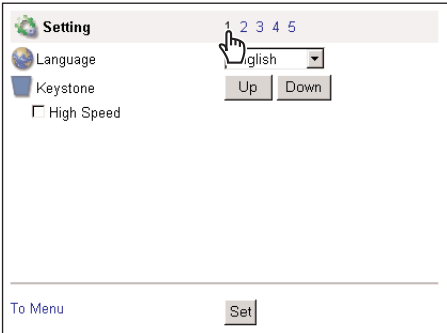

Item	Description
Language	Changes the on-screen menu language of the projector.
Keystone.....	Corrects the keystone distortion of the projected image on the screen. It moves quickly if the “High Speed” is checked.

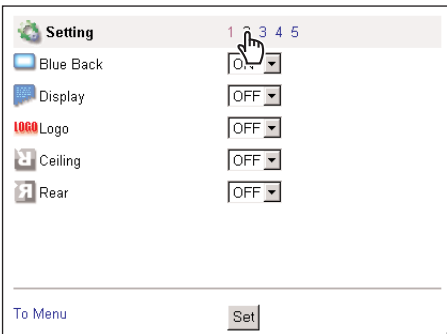

Item	Description
Blue Back	Switches on or off the blue images on the screen when no input signal received.
Display	Switches on or off the on-screen menu display on the screen.
Logo	Sets on or off the logo display on the screen during the startup.
Ceiling.....	Sets the image top/bottom and left/right reversed.
Rear	Sets the image left/right reversed.

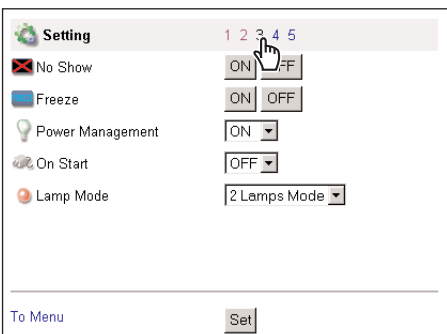

Item	Description
No Show	Sets the image black out mode.
Freeze.....	Sets the image frozen mode.
Power Management.....	Sets the automatic lamp turn-off mode if the input signal is interrupted and no control key is pressed for 5 minutes and 30 seconds.
On Start	Sets the power-on mode when turning on the mains switch.
Lamp Mode.....	Switches lamp mode 1 lamp or 2 lamps mode, or 2 lamps or 4 lamps mode.

* The displayed items may differ from the actual depending on the functions of projector you use.

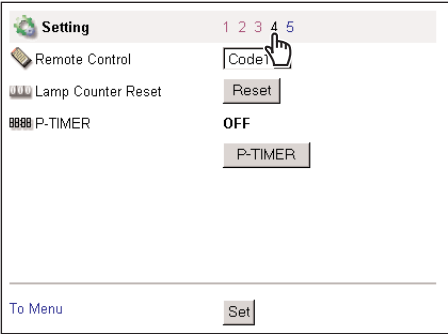

Item	Description
Remote ControlSets one of 2 types remote control codes.
Lamp Counter ResetResets the lamp use-time. Reset when replaced lamp.
P-TIMERUsed to display the timer on the screen. The status is changed as OFF -> STOP -> ON when this button is pressed repeatedly.

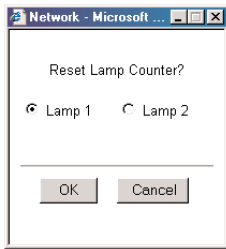

(Set JavaScript On)

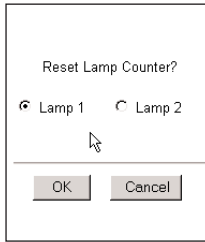

(Set JavaScript Off)

About Lamp Counter reset

The confirmation window as the left will appear when the Reset button of the "Lamp Counter Reset" is pressed. Select which lamp counter is to be reset with the radio button and then press the OK button.

* In case of 2 lamps model

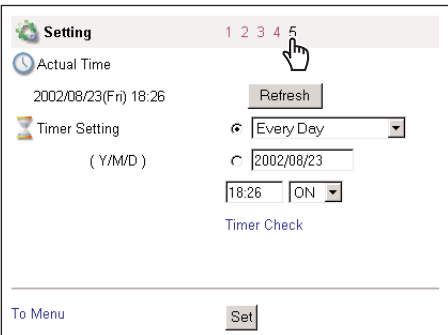

Item	Description
Actual TimeDisplays the current time set to the projector.
Timer SettingFunction to switch on or off the projector at the programmed date and time. Please see chapter "How to set the Timer" for further instructions.

There are various kind of ways to change the JavaScript preference depending on the web browser's version and application. Please refer to chapter "Appendix: Web browser setting/Active Script (JavaScript enable)" on page 72.

How to set the Timer

This function is used to turn the projector off or on at a programmed day/date and time. Follow the below steps for setting.

1 Set a day or date

To set the timer event at same time everyday, select "day" entry with radio button and then select desired day with the pull-down menu button. The selectable days are as follows:

- Same time everyday
- Every week (a day from Monday to Sunday)
- Every week (Monday to Friday) - Every week (Monday to Saturday)

To set the timer event on specified date, select "date" entry with radio button and then type the date with (Year/Month/Date) format.

Ex.: Type [2002/08/20] if you specify [August 20, 2002].

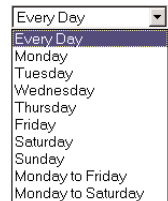
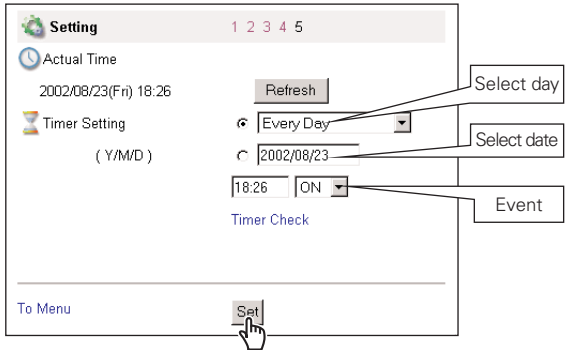

2 Set a time

Type the time with (Hour:Minute) and 24 hours format.

Ex.: Type [18:25] if you specify [PM 6 o'clock and 25 minutes].

3 Select an event "ON" or "OFF".

Select an event **ON** or **OFF** with the pull-down menu button to turn on or off the projector.

4 Register an event

Press the **Set** button to register the set timer event. Repeat steps 1 to 4 for another timer event setting.

Check the Timer events

To check the set timer events, click on the **Timer Check** linked text.

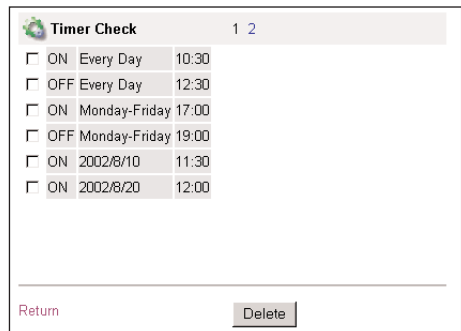

Getting the current time

The displayed time is the value set when the setting page was displayed. This time value is not updated automatically. To update the display time press the **Refresh** button.

Notes on timer setting

Up to 10 timer events can be registered. Timer events always operate according to the next valid event depending on the projector's power status. In the example below, event 3 turns on the projector so next event 4 (also turning on projector) will not be effective because the projector is already turned on. Similarly, when the projector is turned off by event 5, event 6 OFF will not be effective in turning it off again. But these secondary events (event 4 and event 6) will become effective if a person turns off the projector (after event 3 and before event 4) or turns on the projector (after event 5 and before event 6).

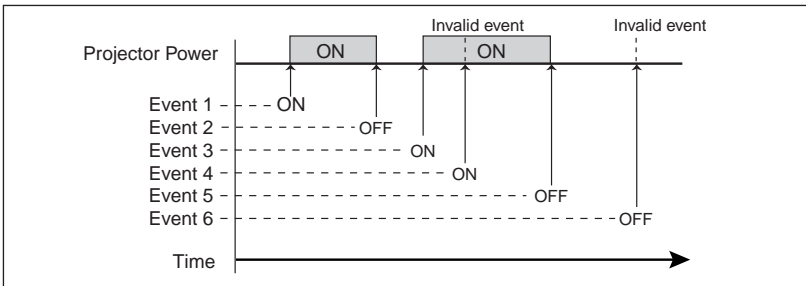

- When the timer events are set at the same time, the last event set will override the previous events. For example, if there is an event like "On at 8:00 everyday" and then new event is set like "Off at 8:00 everyday", only the last setting event is effective.
- When the timer event **ON** occurs during cooling down period, this is invalid event because the projector cannot be turned on during this cooling down period.

Cancel the timer

To cancel the timer event, check the timer event you want to delete and then press the **Delete** button.

Timer Check		1 2
<input type="checkbox"/>	ON Every Day 10:30	
<input checked="" type="checkbox"/>	OFF Every Day 12:30	
<input checked="" type="checkbox"/>	ON Monday-Friday 17:00	
<input type="checkbox"/>	OFF Monday-Friday 19:00	

- The timer operates by using the clock function provided in this product. Before setting the timer, please confirm that the current date and time are set correctly. Timer and clock functions are functioning using a lithium battery provided in this product. When the battery runs down, the clock and timer functions will not operate correctly. Consult your local dealer for the replacement of battery. The replacement must be carried out by a qualified service personnel.



Service

This function sets parameters for service items of the projector. As these service items are used mainly for maintenance, please use the default setting unless a change is needed.

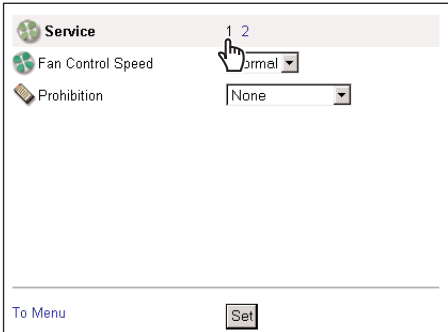

Item	Description
Fan Control Speed	Sets fan control speed with Maximum or Normal.
Prohibition	Sets the prohibition of the projector control by the remote control or the keys on the projector.

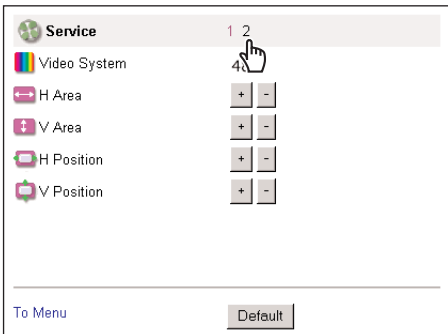
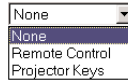

Item	Description
Video System	Displays the current video system mode.
H Area*	Adjusts the horizontal effective area.
V Area*	Adjusts the vertical effective area.
H Position*	moves image horizontally
V Position*	moves image vertically.

* It can not be displayed in the computer mode.

To restore the setting, press the **Default** button.

- The indication of video system in this page is displayed as follows.

Video System	Input Signal
480I	NTSC [VIDEO], [S-VIDEO], [Y, Cb/Pb, Cr/Pr]
480P	NTSC [Y, Cb/Pb, Cr/Pr]
575I	PAL [VIDEO], [S-VIDEO], [Y, Cb/Pb, Cr/Pr]
575P	PAL [Y, Cb/Pb, Cr/Pr]
720P	[Y, Pb, Pr]
1035I	[Y, Pb, Pr]
1080I60	[Y, Pb, Pr]
1080I50	[Y, Pb, Pr]

✍ The adjustments of H/V Area and Position are effective only for video input mode. These adjustment values are stored with each video system mode as the above.



Save Actual Adjustment

This function is to save and load the control values of the projector. The storable control items are Input, PC, System, Image and Screen controls, and these control items differ from each selected input mode and functions of the projector you use.

1 Adjust and set the controls

Set the controls properly according to the selected source. (see pages 38-44 for further adjustment)

2 Select the Save page

Click on the **Save** icon from the control menu. The setting page is displayed as the right. Change pages by clicking on the page numbers "1" to "7" linked text and check the current settings. For further information please see the next page.

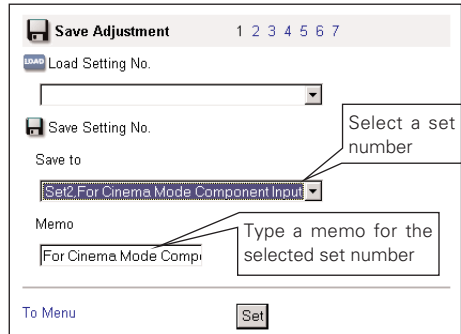

3 Name the current setting

Select a set number (Set1 to set10) you intend to store current settings with the pull-down menu button of the **Save Setting No.:** **Save to.** Name this set number onto the **Memo** text area.

4 Save the current setting

Press the **Set** button to store the current setting and name into the selected set number.

✓ You can store up to 10 sets of controls.

Check the Save items

Browse pages by clicking on the page numbers and check each setting status. The pages for the save items are constructed by 7 pages. The contents of the pages may differ from the actual depending on the selected input mode and the function of the projector.

Save Adjustment 1 2 3 4 5 6 7

Actual Adjustment

Input

SLOT2 RGB

PC Adjustment

Current Mode XGA 1

Fine Sync 16

Total Dots 1344

[To Menu](#)

Save Adjustment 1 2 3 4 5 6 7

Horizontal 99

Vertical 17

Clamp 4

Display Area H 1024

Display Area V 768

Full Screen ON

[To Menu](#)

Save Adjustment 1 2 3 4 5 6 7

System Adjustment

Color System Setting AUTO

Screen

Aspect Normal

[To Menu](#)

Save Adjustment 1 2 3 4 5 6 7

Image Adjustment

Original Mode Standard

Contrast 32

Brightness 32

Color 32

Tint 32

[To Menu](#)

Save Adjustment 1 2 3 4 5 6 7

White Balance

Color Temp. Mid

Red 32

Green 32

Blue 32

[To Menu](#)

Save Adjustment 1 2 3 4 5 6 7

Sharpness 8

Gamma 8

Noise Reduction OFF

Progressive Scan ON

[To Menu](#)

Load a control set

Select your desired set number with the pull-down menu button of the **Load Setting No.** and then press the **Set** button. The setting values of the selected set number are applied to the current settings.

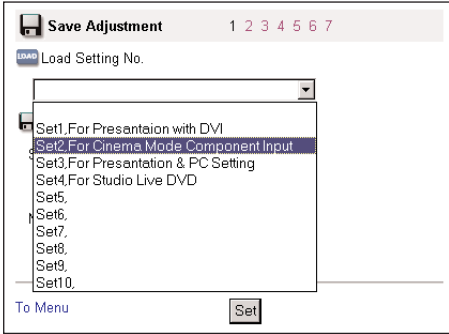

Example of setting

- ⚡ If the contents of the saved set are not match for the slot equipped on the projector, the invalid alert message may be displayed. For example, the message "Invalid setting for SLOT1" will be displayed in the following case.

Example: In case of after setting the DVI computer input for SLOT1 and then it was changed to video input board.



Control the projector's menu

Click on the **Menu** linked text on the main menu. The following menu control page is displayed. This page is to control the on-screen display menu of the projector.

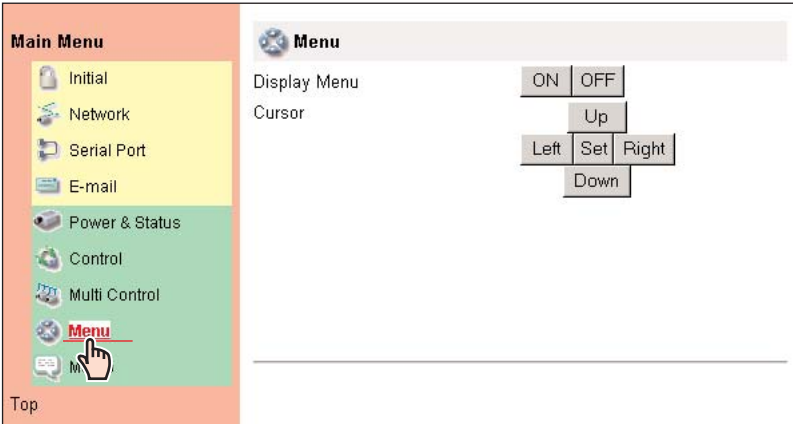

Item	Description
Display MenuTo switch the on-screen display menu on or off by pressing the ON or OFF button. The same operation with the MENU button on the projector and remote control handset.
CursorUsed to select an item or adjust value in on-screen menu by pressing the Up , Down , Left and Right button. The same operation with the pointers on the projector and remote control handset. Used to execute the item selected by pressing the Set button. The same operation with the SELECT button on the projector and remote control handset.



Make a memo

Select the Memo setting page by clicking on the **Memo** linked text on the main menu. The following setting page is displayed. It is convenient to use as a memo for the simple description where the projector is placed in. This note will be displayed on the login page.

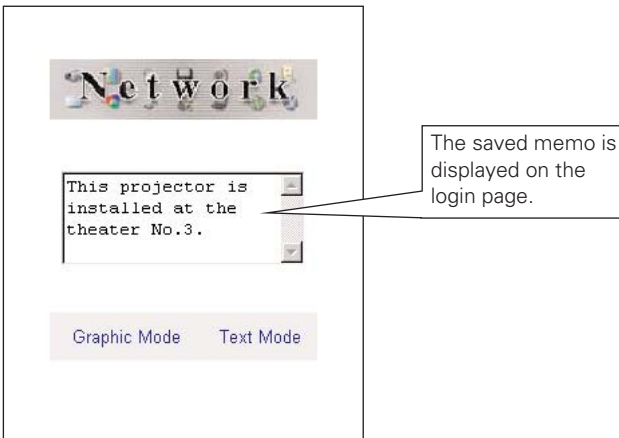
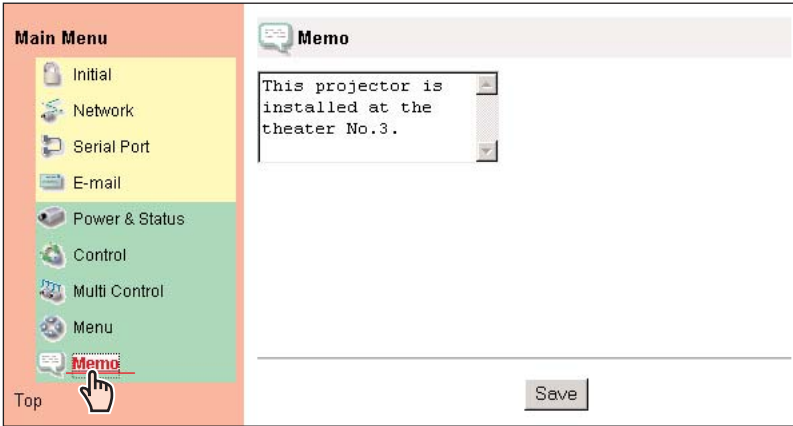

4

Controlling the Multi-Projectors



Multi-Control

This function enables control of multiple projectors equipped with the Network Boards that are connected to the network at the same time. Click on the **Multi Control** linked text on the main menu to display the control page.

Note:

To control the multiple projectors, each projector must have the same password.

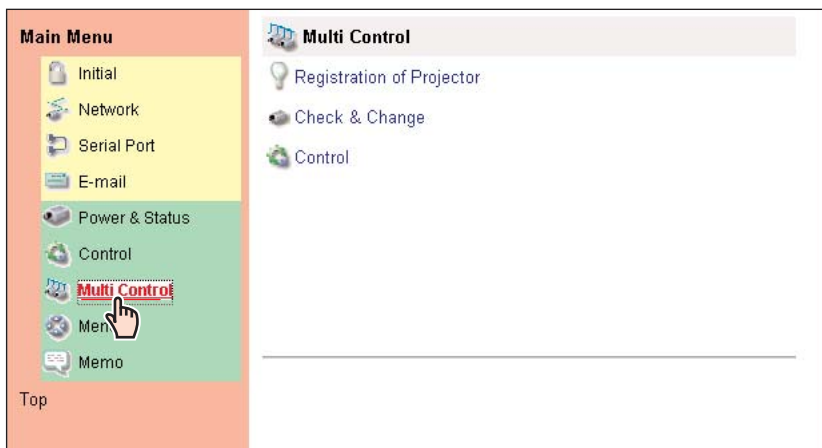

Example of multi control

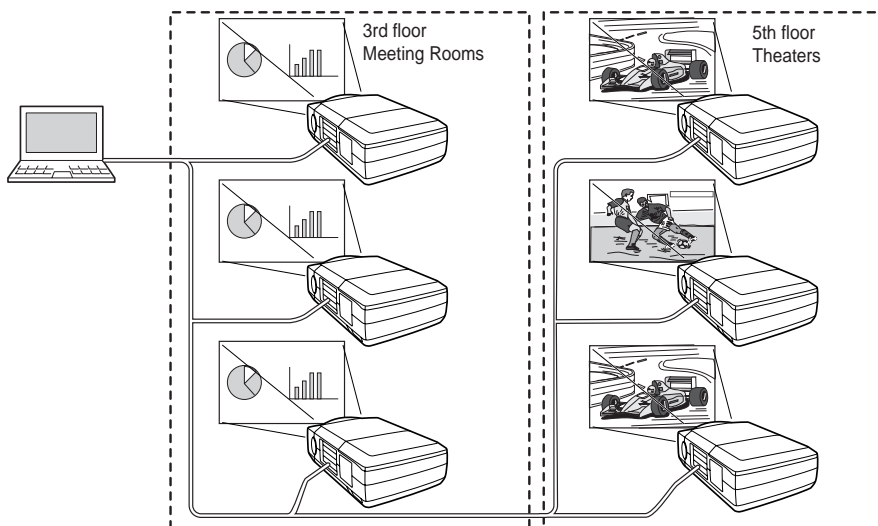

Register IP address and projector name

Click on the **Registration of Projector** linked text to display the registration page. Type the IP address and projector name*1 if required and the press the **Register** button.



Registration of Projector

IP Address

Projector Name

[Check](#)

[Return](#)

Check IP address and projector name

To check the registered information, click on the **Check & Change** linked text. The registered information of the projector is listed as the right.

* The word "None" is displayed if the projector name is not registered.

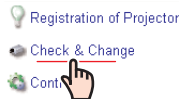

Change 1 2 IP address

● TheaterNo.1	192.168.0.100	ON
● TheaterNo.2	192.168.0.200	ON
● PJ100	192.168.0.2	ON
● TheaterNo5	192.168.100.5	ON
● Cinema101	192.168.00.201	ON

Projector name

When you click on a listed IP address, the login page for the selected projector will be displayed with a new window and then enter the password for this projector and login.

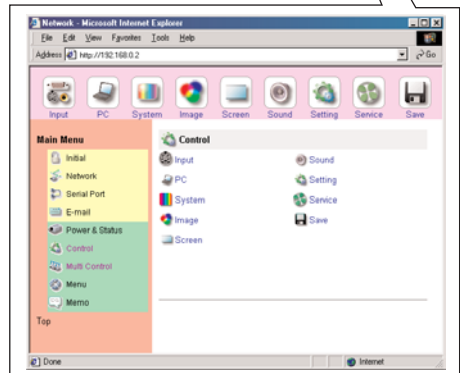

*1 Normally, the projector in the network is recognized with the IP address. This product allows you to name the projector instead of the IP address. By registering the projector's nickname like "MeetingRoom101", it can be managed and recognized easily. If you use the DNS server, register the host name registered to the DNS server as projector name. For further information please consult your network administrator.

✂ You can register the projectors up to 100 sets for the multi-control.

Exclude/Add/Delete a projector

To change the mode of the registered projectors, Select a mode with the pull-down menu button under the IP address of the target projector and then press the **Set** button.

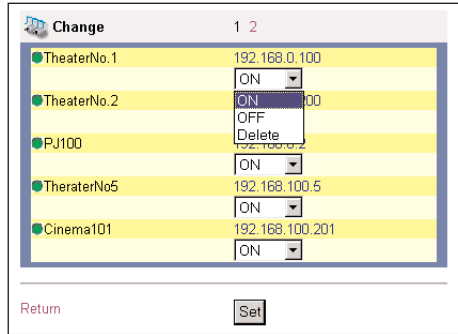

Mode	Operation
OFF	: Exclude from the multi-control
ON	: Add to the multi-control
Delete	: Delete from the multi-control

Status

If some of the registered projectors are deactivated by some means (such as disconnecting the power source, disconnecting the LAN cable, disconnecting from the network), control changes will continue to be effective for the projectors that are still activated. At the same time, the deactivated projectors are excluded from the multi-control. The status of the registered projectors are indicated under the projector name. See the table below for status indications.

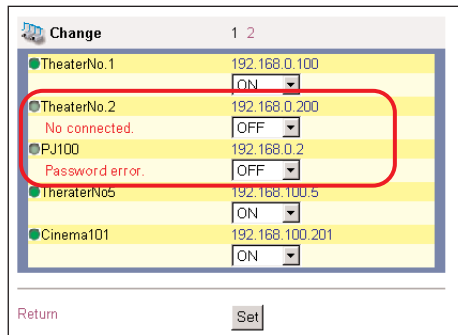

Status	Description
(blank)The projector is connected to the network correctly
No connectionThe projector may not be connected to the network. Please check the connection and network configuration of this projector.
Password errorThe login password is incorrect. The password for the multi-controlled projectors must be the same. Change password of this projector to the common password.

- ✍ If the multi-controlled projector is in the standby mode, any change is not effective except timer setting.
- ✍ It is recommended that a specified projector should be chosen for setting when you use this multi-control function. The control for the multi-controlled projectors will become too complicated operation if this function is used for each projector.
- ✍ If the registered projector is not connected to the network, it will take some time to complete the multi-control operation because the network board is waiting for the response from each registered projector.

Control

Display the control page by clicking on the **Control** linked text on the multi-control page. The setting pages are constructed from 1 to 6 page and each items are indicated on the next page.

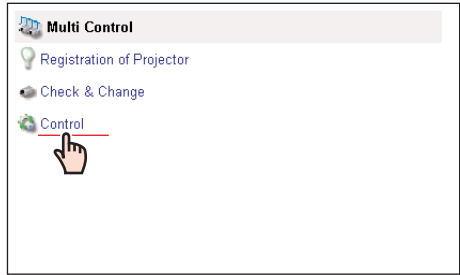

Load and apply the setting value

The control sets saved for each projector (p. 50) can be used while the multi-controlled projectors function is being used. Select a setting number from the item **Load Setting No.** with the pull-down menu button and then press the **Set** button. The control values stored with selected set number for each projector will be applied to the individual projector assigned to that set. The control values will not be applied to all of the projectors under the multi-control.

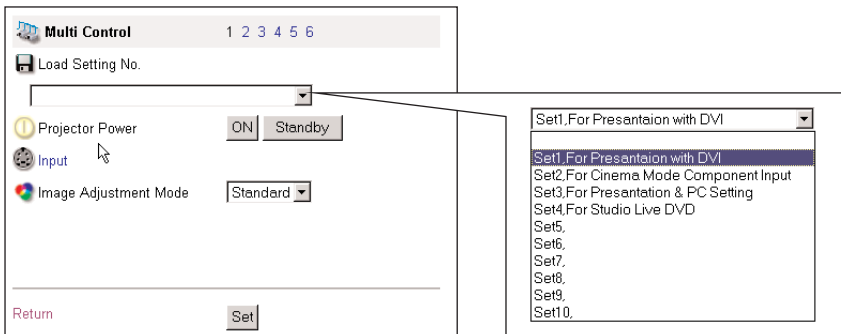

⚡ If loading a set to the multiple projectors, the contents of the set must be effective to current accessed projector. If not, the multi-control can not be performed.

Example: If the DVI computer input for SLOT1 is set into the "Set1" and the current accessed projector has a video board on the SLOT1, the load set will become invalid this time and the loading of set for the another projectors will not be carried out.

Control multi-projectors at the same time

The valid controls are shown below. Please refer to chapter “Control the Projector” on page 33 for further control and description. When the control button or setting button is pressed, the registered projectors for the multi-control are controlled at the same time. * These control items differ from each selected input mode and functions of the projector you use.

Multi Control 1 2 3 4 5 6

Aspect

Language

Blue Back

Return

Multi Control 1 2 3 4 5 6

Display

Logo

Ceiling

Rear

No Show

Freeze

Return

Multi Control 1 2 3 4 5 6

Power Management

On Start

Lamp Mode

Remote Control

Return

Multi Control 1 2 3 4 5 6

Actual Time Setting

Actual Time

2002/08/23(Fri) 19:06

Date (Y/M/D)

Time

Return

Multi Control 1 2 3 4 5 6

Actual Time

2002/08/23(Fri) 19:07

Timer Setting

(Y/M/D)

[Timer Check](#)

Return

5

Use of Serial Port

Use of Serial Port



This product provides with a serial control port (RS-232C) to control the external equipment which has an RC-232C port. This function allows external equipment to be controlled by the computer through the network and the projector can be controlled by the external serial controller. Before connecting the external equipment, perform the setting "Serial port setting" described below.

Serial Port setting

This is to set up the serial port on the network board. Display the setting page by clicking on the **Serial Port** linked tex on the main menu. To communicate with external equipment correctly, communication condition must be set to the same values as that the connected equipment is using. After fixing the setting, press the **Set** button*1.

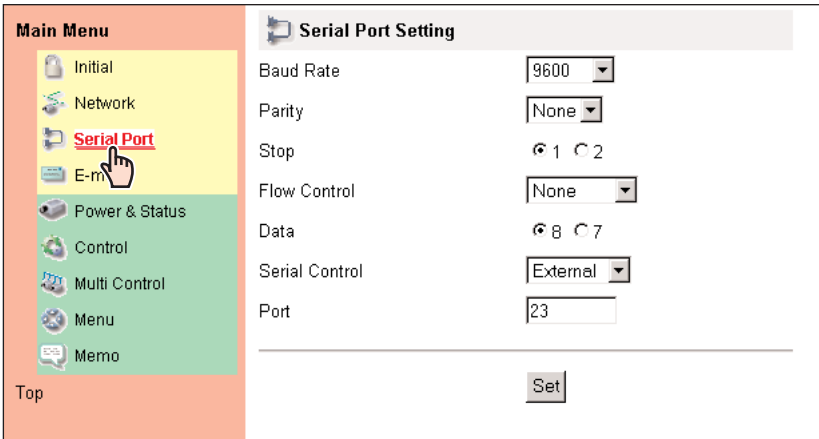

Item	Description
Baud Rate.....	Communication speed for serial port, select with the pull-down menu.
Parity.....	Parity check, the ways for error detecting of the transferred data.
Stop	Stop bit, indicates the end of communication.
Flow Control	Ways for communication flow.
Data	Indicates the length of data
Serial Control	Selects equipment to control
External	Used to select when the external equipment connected to the serial port is controlled by the computer through the LAN port.
Projector.....	Used to select when the projector is controlled by the serial controller connected to the serial port.
Port.....	Indicates the port number of TCP/IP. The default number is 23. Use the same port number specified by application. There are some reserved port number*2. If one of those port numbers is used, the alert dialog window will appear and let you know that it is an invalid port number.

Setting to control the equipment connected to the serial port from the computer

- Serial Control :Selects "External"
- Port :Sets according to the computer specified port no. Do not use port no. 10000*2.
- Other Settings :Sets according to the communication condition of the equipment

Data	<input checked="" type="radio"/> 8 <input type="radio"/> 7
Serial Control	External
Port	External Projector

Setting to control the projector from the serial controller connected to the serial port

- Serial Control :Selects "Projector"
- Port :Not specified. Do not use port no. 10000*2.
- Other Settings :Sets according to the communication condition of the serial controller

Data	<input checked="" type="radio"/> 8 <input type="radio"/> 7
Serial Control	Projector
Port	External Projector

Setting to control the projector from the computer through the LAN port

- Serial Control :Not specified
- Port :Not specified
- Other Settings :Not specified

Data	<input checked="" type="radio"/> 8 <input type="radio"/> 7
Serial Control	External
Port	23

* The port no. of the computer is must be used with 10000.

*1 This product will restart automatically when the "Port" or "Serial Control" is changed and it takes about 40 seconds.

*2 The reserved port numbers are http (80), ftp (21), telnet (23), etc. The port no. 10000 is reserved to control the projector through the LAN port.

✍ Exclusive driver software for control of the external equipment is required. This product does not provide any driver software. Please consult your local dealer.

✍ There are 2 types of RS-232C serial cable, Normal and Reverse type. Usually, when connecting between this product and a projector or a computer, use Reverse type of serial cable. When connecting DVD player etc., use Normal type.

Control Examples

Example 1

Controlling AV equipment through network

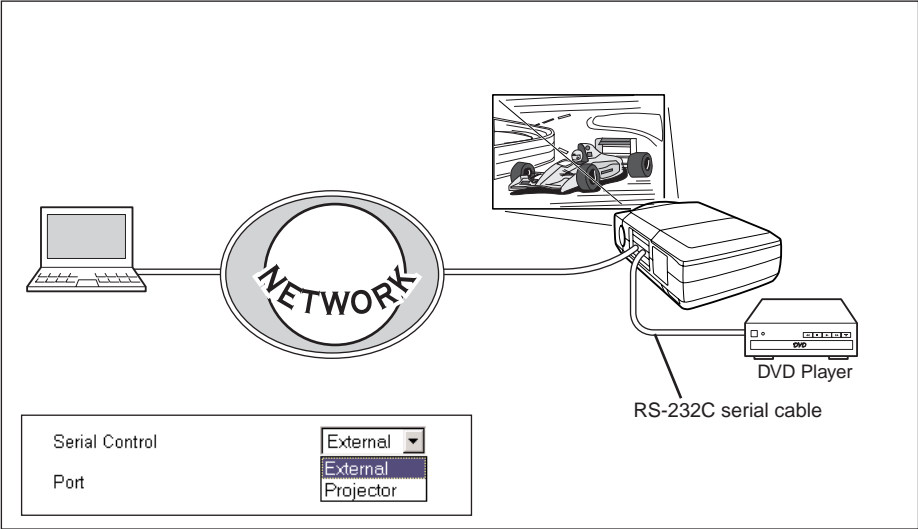

Example 2

Controlling a projector which is not on the network function through network.

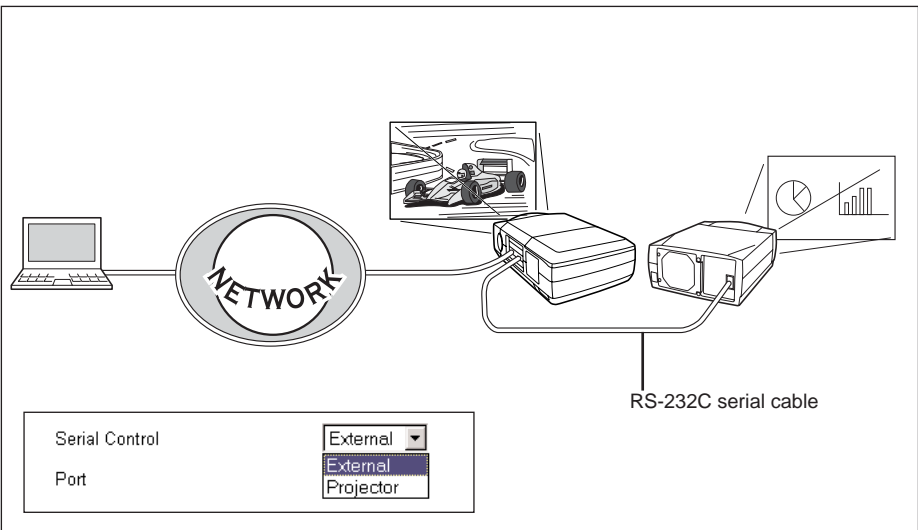

Example 3

Controlling the projector with the serial controller through the serial port (RS-232C).

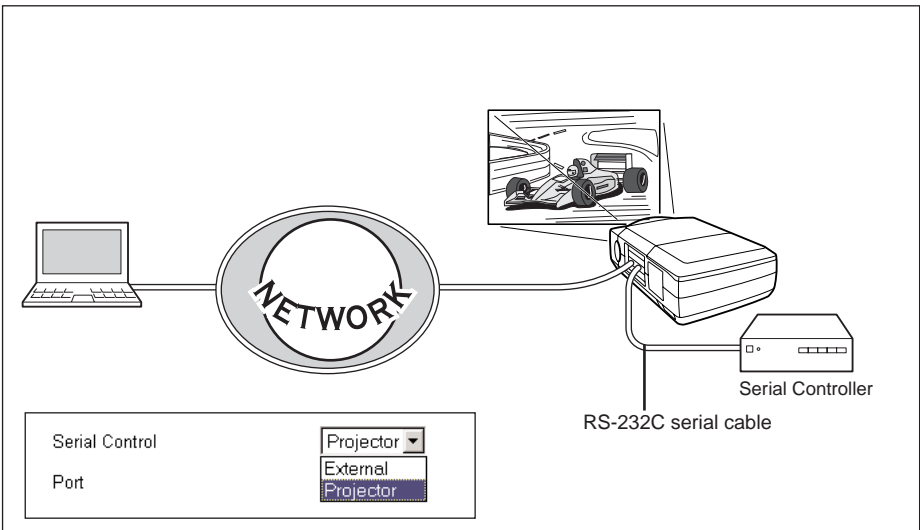

When connecting the peripheral equipment to this network board, you should notice the type of serial cables. At the factory shipping, the polarity of serial port on the network board is set to the reverse (cross) type. When connecting the peripheral equipment, please use an optimum serial cable according to the polarity of the port on the equipment. And this product provides a socket to switch the polarity of the serial port. By switching the socket on the board as shown below, it is possible to switch the polarity of the port either the normal (straight) type or the reverse (cross) type. By means of this, you can use both kinds of the serial cable. For further pin allocation please see the Port Specification on page 82.

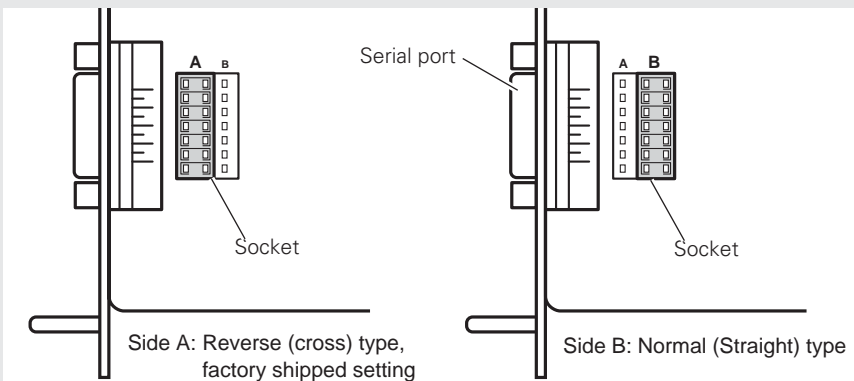

Use of Telnet

You can control the equipment connected to the serial port on the network board and control projector itself by using the telnet application*1 installed on your computer. The following is a control example of external equipment. The telnet application is required to use commands*2 which control the external equipment.

Preparation

- 1 Turn the projector off with the mains switch and connect an external equipment to the serial port with an RS-232C serial cable.
- 2 Turn the projector and external equipment on.
- 3 Display the setting page by clicking on the **Serial Port** linked text on the main menu with the web browser. (refer to page 62).
- 4 Change the serial port setting to be the same communication condition as the connected external equipment and then press the **Set** button.

The following example setting is for our projector communication condition. When controlling our projector set as follows:

Baud rate19200
ParityNONE
Stop1
Flow ControlNONE
Data8
Serial ControlExternal
Port23

Control

(For example, in case of using the Telnet application in the Windows 98.)

- 1 Select the **Run...** submenu from the **Start** menu on the computer. Type "telnet" onto the **Open** text area on the displayed window and press the **OK** button.

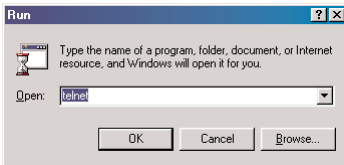

- 2 Launch the telnet application and the following window will be displayed. Select the **Remote System** from the **Connect** pulldown menu.



*1 For further instructions about the telnet application, please see the on-line guide on your computer. Macintosh does not provide the telnet application.

*2 The commands are defined by each product independently, so please consult the manufacturer or sales dealer for further information of the commands.

- 3 The following window will appear. Type as follows and then press the **Connect** button.

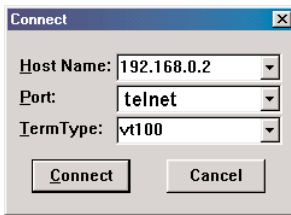

Host name : 192.168.0.2
(type projector IP address)
Port : telnet or 23
Terminal type : vt100

- 4 When communication is established, the word "PASSWORD:" appears on the window. Type the login password* for the projector and then press the "Enter" key on the keyboard. If you do not register the login password, just press the "Enter" key.

When the word "Hello" is replied, login has been successful.

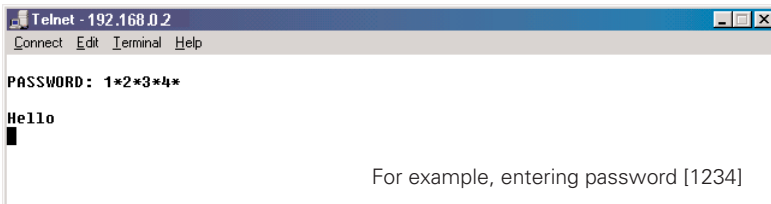

- 5 Type the commands from the key board to control the external equipment and then enter the "Enter" key for termination. For example, type "C00" and enter the "Enter" key. The projector will be turned on. The "C00" is a command to turn the projector on.

To disconnect the communication, select the **Disconnect** sub menu from the **Connect** pulldown menu. To quit the telnet application, select the **Quit telnet** sub menu from the **Connect** menu.

* The password is a login password decided on page 17 or 30. If the authentication of the entered password is failed 4 times continuously, the communication will be disconnected automatically. Please try again for the connection.

Control the projector with Telnet

This product allows you to control the projector by using the Telnet application. Normally, it is used to control the external equipment connected to the serial port and also control the projector itself by specifying the telnet port no.10000.

Specify port no. 10000 as the right on the serial port setting page. This function does not depend on other setting items.

In the setting of the computer, specify the port no. 10000 at the procedure 3 on the previous setting example page as the below.

Serial Port Setting

Baud Rate: 9600
 Parity: None
 Stop: 1
 Flow Control: None
 Data: 8
 Serial Control: External
 Port: 10000

Set

Connect

Host Name: 192.168.0.2
 Port: 10000
 TermType: vt100

Connect Cancel

Host name : 192.168.0.2
 (type a projector IP address)
 Port : 10000
 Terminal type : vt100

After established the communication, type the password and the command for controlling the projector and then enter the "Enter" key.

The right table shows the typical command lists for controlling our projectors and please consult your local dealer for further information of another commands.

Command list table

Command	Function
C00	Turn the projector on
C01	Turn the projector off
C05	Selects SLOT1
C06	Selects SLOT2
C07	Selects SLOT3
C08	Selects SLOT4*
C09	Volume up
C0A	Volume down
C0B	Mute on
C0C	Mute off
C0D	Video mute on
C0E	Video mute off
C1C	Menu display on
C1D	menu display off

* Only effective for the 4 slots model.

6

Appendix:A

Connection examples

Web browser setting

Technical data

Examples of Connection

Peer-To-Peer connection

Connect the projector (PJ01) to the control computer (PC05) directly

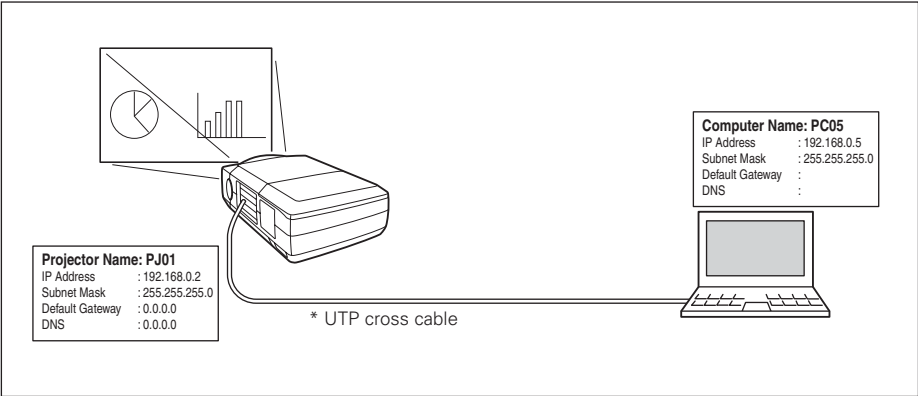

Connect the projector (PJ01) to the control computer (PC05) via the hub.

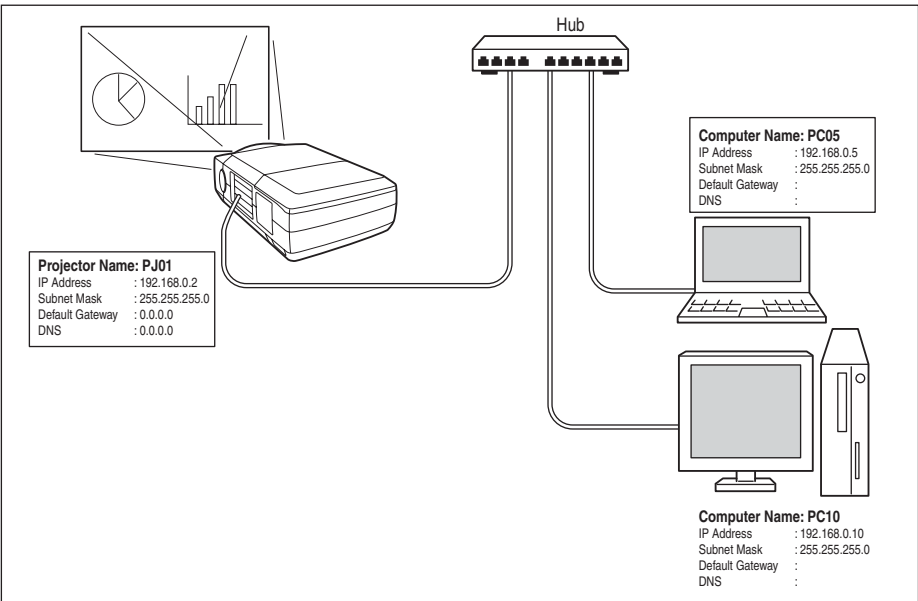

✍ When the projector is connected to the computer directly without hub, the UTP cross cable should be used .

The gateway (Router) installed in the network

Connect the projector (PJ01) to the control computer (PC05) via the gateway.

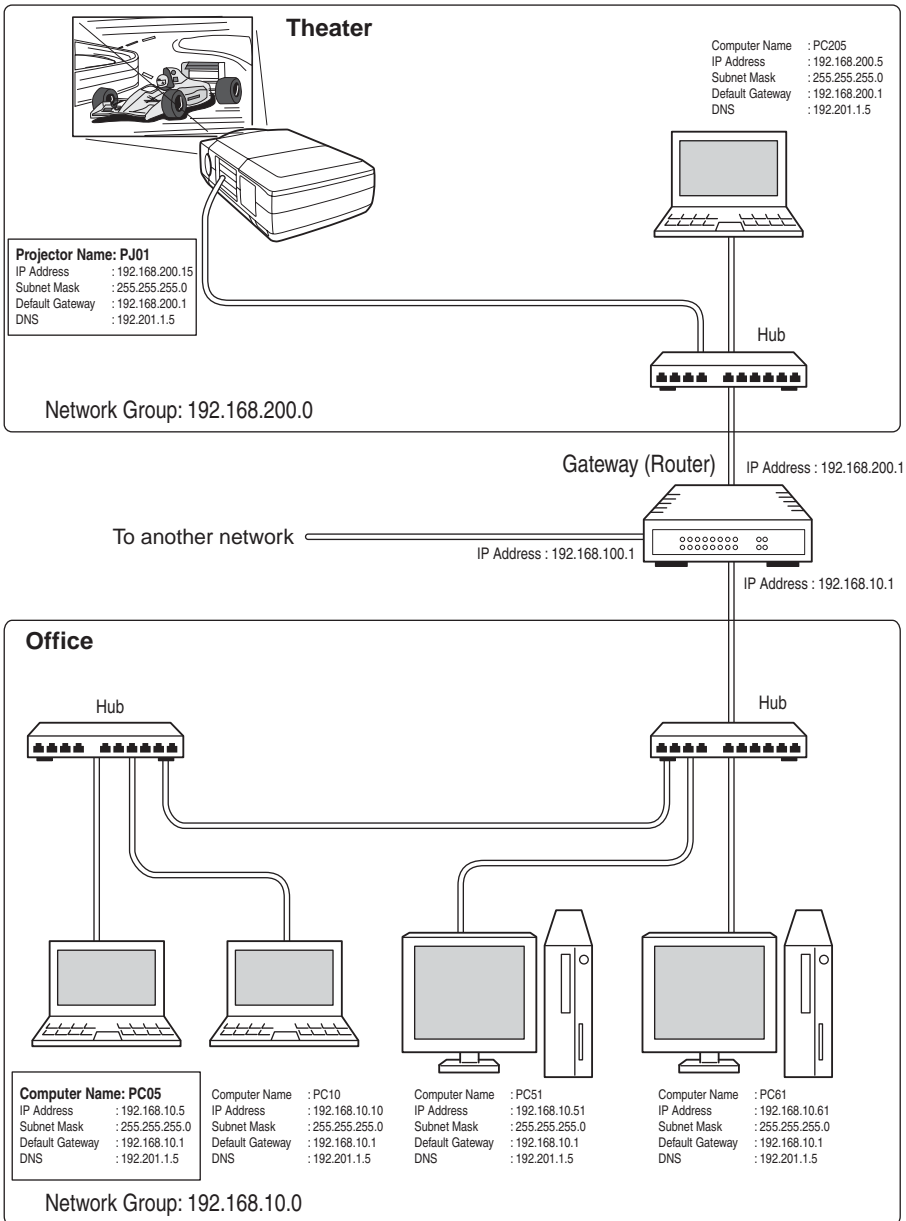

ENGLISH

Web browser setting

This product is designed enable the projector to be set up and controlled from an Internet web browser. Depending on the preference settings of the web browser, some control functions may not be available. Please make sure that the following functions are set up properly in the web browser.

Active Script/JavaScript enable

There are some control items used with the JavaScript function in the setting pages. If the web browser is set not to use this JavaScript function, it may not control the projector properly. In this case, the following warning message will be displayed on the top of the page. To enable the JavaScript, please see further instructions on the next page.

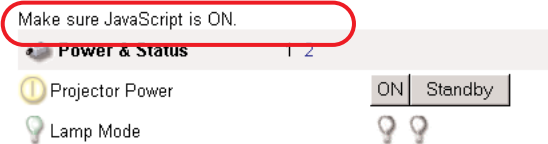
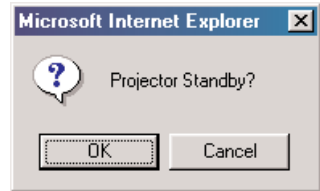

Proxy setting

In some cases, your web browser is set up to use the proxy server for the internet or intranet connection. In this case, when you install this product into the local network, you should set up the proxy setting of web browser preference correctly. Especially when connecting the projector and computer with a UTP cross cable directly, or when the network does not provide the proxy server, make sure that "not use proxy server" is set up in your web browser preference. To set up the proxy setting, please see further instructions on next page.

There are various ways to change your browser preferences depending on the version, Windows, Macintosh or applications. Please see the setting instructions on next page for example and also refer to on-line help of your web browser.

Setting examples: OS/Browsers

Windows 95/98

Internet Explorer v.5.5

ActiveScript setting

Select the **Internet Options** menu from the **Tool** menu on the web browser and then select **Security** tab and press the **Customize Level...** button. On the security setting window, scroll down and find the **Scripting** item, make sure that the "Enable" is selected in item **Active Scripting**.

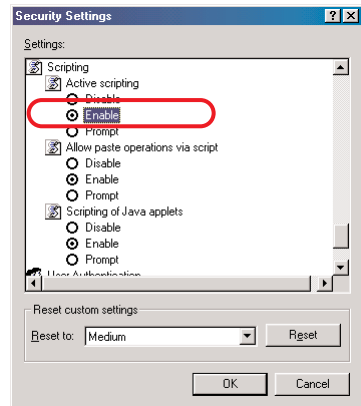
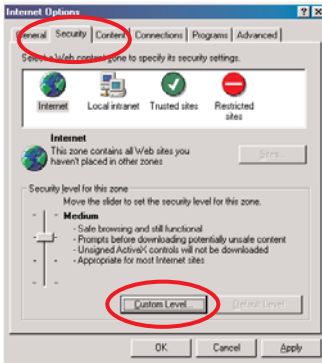

Proxy setting

Select the **Internet Options** menu from the **Tool** menu on the web browser and then select **Connection** tab and press the **LAN Settings** button. Properly set up your web browser's the proxy server settings according to the local area network environment to which the projector is connected.

- Using proxy server

To use an external internet connection from the local area network, check the item **Use a proxy server** and enter the proxy server address and port correctly in the proxy settings window. For further instruction please consult your network administrator.

- Not using proxy server

Uncheck the item **Use a proxy server**. If you connect the projector to the computer directly with UTP cross cable, this must be unchecked.

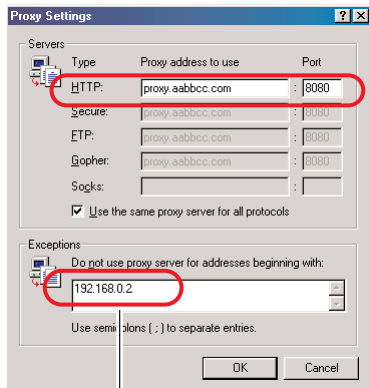
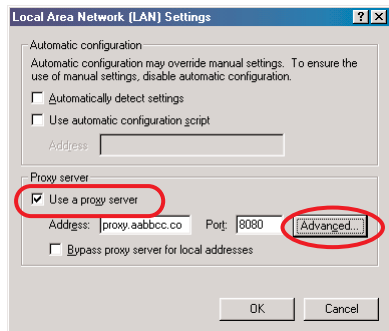
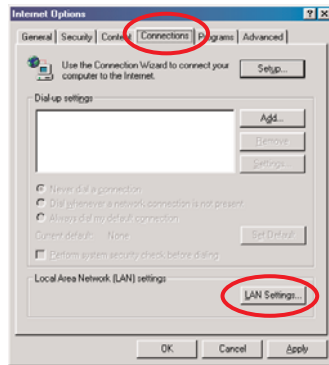

To designate proxy settings that will not use the proxy server when accessing the projector installed in the local area network, enter the IP address or domain name here.

Netscape Navigator v.4.7

JavaScript Setting

Select the **Preference** menu from the **Edit** menu on the web browser and then select the item **Advanced** in the **Category** column. Make sure that the **Enable JavaScript** is checked.

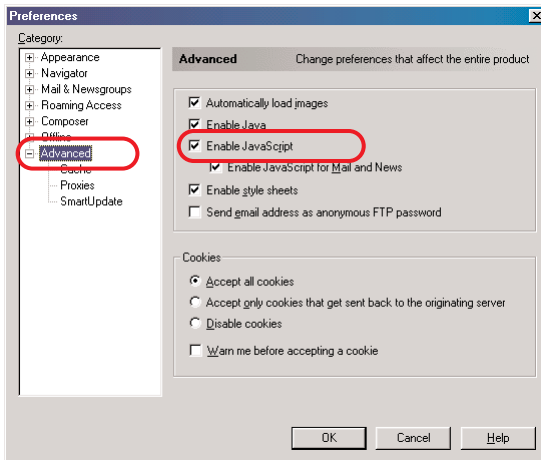

Proxy setting

Select the **Preference** menu from the **Edit** menu on the web browser and then select the item **Advanced/Proxies** in the **Category** column. Properly set up your web browser's the proxy server settings according to the local area network environment to which the projector is connected.

- Using proxy server

When you use an external internet connection from the local area network, select the item **Manual proxy configuration** and press the **View** button. The proxy setting window will appear. Enter the proxy server address and port number correctly on the **HTTP** item in the proxy settings window. For further instruction please consult your network administrator.

- Not using proxy server

Select the item **Direct connection to the Internet** in the proxy setting window. If you connect the projector to the computer directly with UTP cross cable, this must be selected.

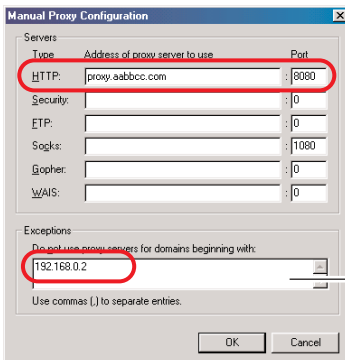
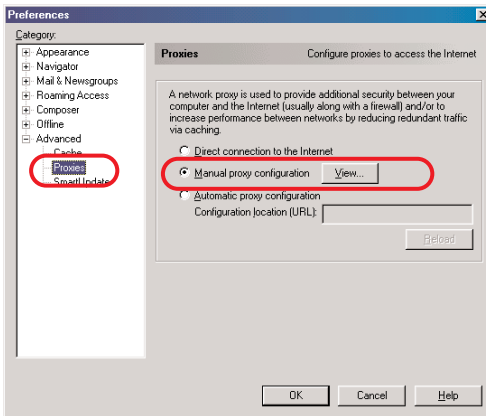

To designate proxy settings that will not use the proxy server when accessing the projector installed in the local area network, enter the IP address or domain name here.

Mac OS 8.6

Internet Explorer v.5.0

ActiveScript setting

Select the **Preference** menu from the **Edit** menu on the web browser and then select **Web Content** under the **Web Browser** heading the preference settings window. Make sure that the **Enable scripting** is checked in the **Active Content** column.

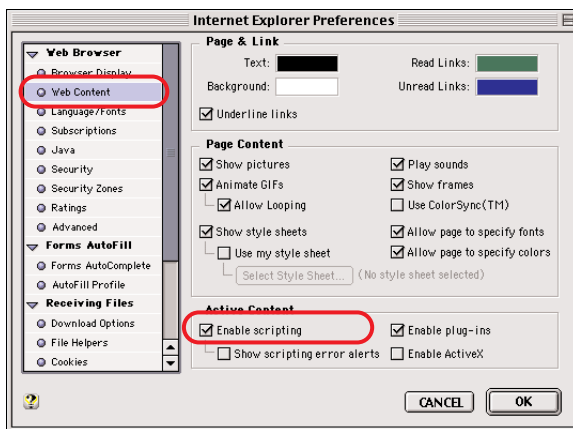

Proxy setting

Select the **Preference** menu from the **Edit** menu on the web browser and then select **Proxies** under the **Network** heading the preference settings window. Properly set up your web browser's the proxy server settings according to the local area network environment to which the projector is connected.

- Using proxy server

When you use an external Internet connection from the local area network, check the item **Web Proxy** and enter the proxy server address correctly. To make advanced settings, press the **Settings** button to display the Web proxy settings window. For further instruction please consult your network administrator.

- Not using proxy server

Uncheck the item **Web Proxy**.

If you connect the projector to the computer directly with UTP cross cable, this must be unchecked.

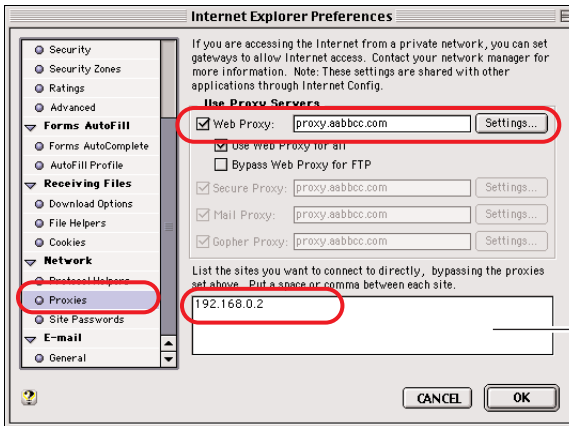

To designate proxy settings that will not use the proxy server when accessing the projector installed in the local area network, enter the IP address or domain name here.

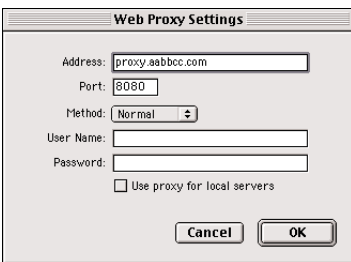

Netscape Navigator v.4.7

JavaScript Setting

Select the **Preference** menu from the **Edit** menu on the web browser and then select the item **Advanced** in the **Category** column. Make sure that **Enable JavaScript** is checked.

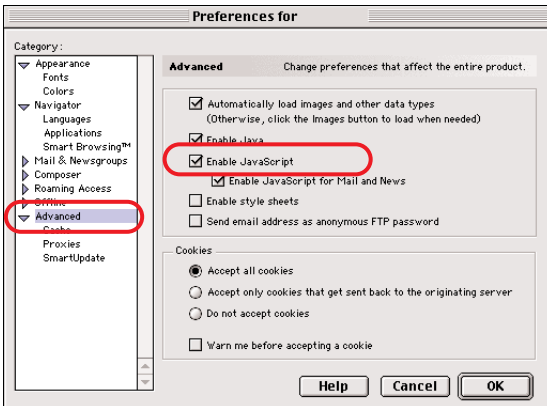

Proxy setting

Select the **Preference** menu from the **Edit** menu on the web browser and then select **Proxies** under the **Advanced** heading in the Category column. Properly set up your web browser's the proxy server settings according to the local area network environment to which the projector is connected.

- Using proxy server

When you use an external Internet connection from the local area network, select item **Manual proxy configuration** and press the **Configure** button. The proxy setting window will appear. Enter the proxy server address and port number correctly on the **HTTP proxy** item in the proxy settings window. For further instruction please consult your network administrator.

- Not using proxy server

Select item **Direct connection to the Internet** in the proxy setting window. If you connect the projector to the computer directly with UTP cross cable, this must be selected.

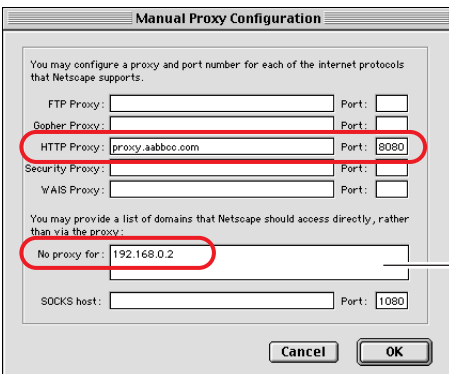
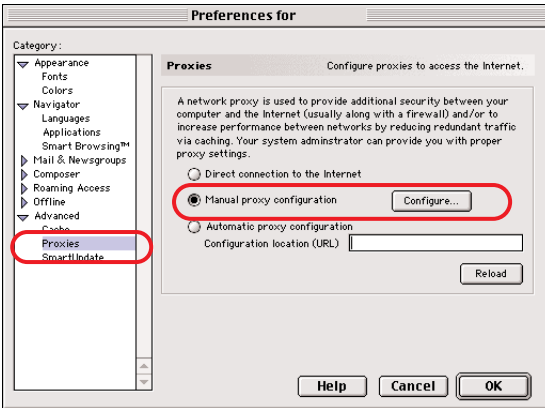

To designate proxy settings that will not use the proxy server when accessing the projector installed in the local area network, enter the IP address or domain name here.

Product specification

Type	Network Board	
LAN interface	Applicant regulation	IEEE802.3 (10Base-T)
		IEEE802.3u (100Base-TX)
	Data transfer speed	10Mbps/100Mbps
	data transfer mode	Half duplex/Full Duplex
Terminal	8-pin modular (RJ-45)	
	Terminal	
Network protocol	TCP/IP specification	TCP/IP
Serial interface	RS-232C	
	Baud rate	0.3/1.2/2.4/4.8/9.6/19.2/28.8/57.6/115.2 Kbps
	Flow control	Hardware flow control (RTS/CTS, Xon/Xoff)
	Parity check	Odd/Even
	Terminal	D sub 9-pin Male
	Power source	
Power consumption	3.0 watts	
Dimensions (W x H x D).....	5.39" x 1.18" x 4.33" (137 x 30 x 110mm)	
Weight	0.34 lbs (155 g)	
Built-in battery	Lithium battery, Type CR2032, 3.0V	
Operating temperature.....	41°F ~ 95 °F (5°C ~ 35 °C)	
Storage temperature	14°F ~ 140°F (-10°C ~ 60°C)	

* The specifications are subject to change without notice.

Port Specification

LAN port specification

8-pin modular connector (RJ-45)

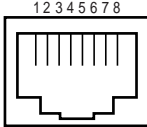

pin No.	Signal	Function
1	TX+	Transfer data (+)
2	TX-	Transfer data (-)
3	RD+	Receive data (+)
4	(not used)	
5	(not used)	
6	RD-	Receive data (-)
7	(not used)	
8	(not used)	

Serial port specification

D sub 9-pin connector (RS-232C)

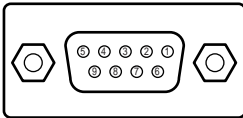

* It is possible to switch the polarity of the serial port as shown in table below by switching the socket on the network board. For further information, please see on page 65. At the factory shipped setting, the socket is set to side A.

Pin No. Socket	Signal Name	
	Side A	Side B
1	CD	-
2	RXD	TXD
3	TXD	RXD
4	DTR	-
5	Ground	Ground
6	DSR	-
7	RTS	-
8	CTS	-
9	-	-

- Explanation of signal names

	Function
CD	Carrier detection
RXD	Receive data
TXD	Transfer data
DTR	Data terminal ready
DSR	Data set ready
RTS	Request to send
CTS	Clear to send
-	Not used

Appendix:B

FAQ

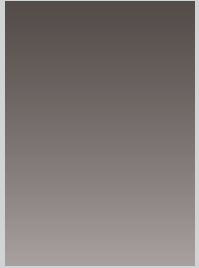

FAQ

Installation/Access

Q Why doesn't the setting page appear in my web browser?

A Following causes are possible. Please check them.

1. The projector is not connected to the network.
 - Check LED indicators status (p.11).
 - Check the connection of LAN cable if the LINK indicator does not illuminate orange.
 - Check the network configuration of the projector if ACT indicator does not illuminate green.
2. Function "Network" in the projector is not set to "ON".
 - Set up by using the projector's on-screen menu (p.14/16).
3. Wrong network configuration of the projector
 - Check the network configuration of the projector by using the projector's on-screen menu (p.14/16).
4. Wrong network configuration of the computer.
 - Check the network configuration of the computer. See chapter "Configure the network of computer" on page 20.
5. The Network Board is used with the default setting. (p.14).
6. The proxy setting of the web browser is not set correctly (p.72).
7. The computer does not provide TCP/IP protocol.

Q No setting page in my web browser? Is the problem in the network or in the projector? I would like to find out the problem whether it is in the network or in the projector

A Check it by the following steps

1. Disconnect the projector from the network and connect the projector and computer with the UTP cross cable directly.
2. Change network configuration of the computer and projector as shown in the example below.

(Projector setting)	(Computer setting)
IP Address : 192.168.0.2	IP Address : 192.168.0.5
Subnet Mask : 255.255.255.0	Subnet Mask : 255.255.255.0
Default gateway : 0.0.0.0	Default gateway : (blank)
DNS : 0.0.0.0	DNS : (blank)

3. Enter the projector's IP address [192.168.0.2] at the "Address" column on the Web browser. [Note] Make sure that the proxy setting of your web browser is set to "Not use a proxy server". See further information on page 72.
4. If the login page appears, this product is operating properly. The problems may be in the network configuration of the computer or in the network. Please try to set up the network by following chapter "Network configuration" on page 15.
If the login page does not appear, please check for proper mounting of this product onto the projector by referring to the "Installation" chapter on pages 9 to 14.

Q How can I restrict access from the computer.

- A**
1. Please use the password authentication function on the login page (p.30).
 2. Please use the IP filtering function provided with the gateway (router) to restrict the accessing from the computer. For further information please consult your network administrator.

Q Can I access the projector installed on the company's local area network from a remote location?

- A**
- There are some ways to access to the projector in the LAN, but you must consult your network administrator.
- ☛ Use of modem
(Connect to the company's network from your home or some other places by using modem.)
 - ☛ Use of private line
(Connect to the company's network from the branch office or maintenance office by using private line.)
 - ☛ Use of internet
(Connect to the company's network from your home, branch office or some other places by using the internet.)

Q We use the DHCP/BOOTP server to assign the IP address. Is it possible to use the Network Board in this network environment?

- A**
- Possible. As the Network Board does not support the DHCP/BOOTP server, the fixed IP address must be configured manually. Please consult your network administrator. (p.24)

Q How can I install several projectors equipped with the Network Board?

A Install and configure network one by one to avoid the IP address collision each other. (p.24)
To configure the IP address please see chapter “Network configuration” on page 15.

Q How many projectors can I control with multi-control function?

A It has been designed to control up to 100 sets but it depends on the network environment.

Password/Login

Q What should I do when I forget the password?

A Select the **Display** icon from the **Setting** menu by using control keys on the projector and then press the **SELECT** button. The current password will appear on the screen. (p.14/17)

Q Can I register the setting page as a web browser “Favorites” or “Bookmarks”?

A Please add the “Login” page to your “Favorites” or “Bookmarks”. Do not add the specified setting page because it will not be able to perform the password authentication correctly.

Operation

Q Why can't I change the controls in the setting page with web browser?

A Please make sure the projector is turned on. If it is in the standby mode, the setting is not effective to the projector. To control the projector with a web browser, the projector must be in the powered-on condition. Also, projectors registered for multi-control cannot have any controls changed if they are in standby mode. But timer and clock settings are always effective, even for projectors in standby mode.

Q Why does it sometimes take a lot of time to complete the page display?

A The display speed of the page depends on the network environment in which both the projector and computer are placed. It may take much time to complete the page display if network traffic is heavy. Please consult your network administrator. By changing the preference of your web browser to "not show pictures", you may have page display more quickly at the heavy network traffic. Please see the browser's on-line help for further information. Also you can select the Text mode for displaying pages quickly (p.26)

Q I use many of the projectors in the network. How can I use names of the projectors to recognize each projector instead of IP addresses?

A You can manage the projectors with nicknames instead of the IP address. Please see chapter "Control the Multi-Projectors" for further information. (p.49) By registering the projector name and IP address with the DNS server, it can be accessed with the nickname from the any computer referred to the DNS server. Please consult your network administrator. (p.31, 57)

Q How many numbers of the E-mail addresses can I register in the E-mail setting page.

A You can register up to 10 addresses.

Q Why am I not receiving E-mail alert messages?

A Make sure that the registered E-mail address and SMTP server address are correct. If the SMTP server is located in your LAN (Local Area network), the address should be set to the SMTP server in your LAN. The SMTP server located outside of your LAN may not be available for security reason. For further information please contact your network administrator. (p.32)

It may be required for the authentication depending on the SMTP server. This product does not support this kind of SMTP server.

Others

Q Can I develop a driver to control external serial equipment?

A This product does not provide any driver software. To control the external equipment connected to the extra serial port, it should be required to clarify the commands and communication condition defined by each equipment. If they are clarified, it can be controlled by using the Telnet application installed on your computer. Please see chapter "Use of telnet" on page 66.

Q Can I control the projector by using the telnet application?

A Possible. Please refer to the chapter "Control the projector with telnet" on page 68.

Q Can I update the firmware of the Network Board.

A It is possible to update the firmware through the network. It is required to have a special tool for the updating. For further information please consult your local dealer. The version number of the firmware is indicated on the lower part of the “Initial Setting” page.

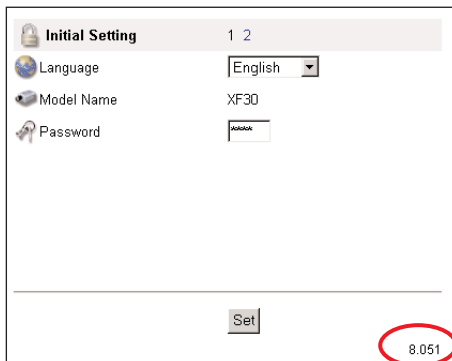

The screenshot shows the 'Initial Setting' page with the following fields:

Initial Setting		1 2
Language	English	▼
Model Name	XF30	
Password	<input type="password" value="password"/>	

At the bottom of the page, there is a 'Set' button and the firmware version number '8.051' is displayed in the bottom right corner, circled in red.

Q What are the rules for IP address assignment?

A If the network is constructed with TCP/IP protocol, a unique IP address is required for each piece of network equipment. The following are basic rules of the assignment.

Rule1

Do not configure the same IP address to the network equipment in the same network group. Each piece of equipment must be assigned a unique IP address.

If the IP address is set [192.168.x.x], the Subnet Mask should be set [255.255.255.0] for example.

Rule2

The start address [xxx.xxx.xxx.0] and the last address [xxx.xxx.xxx.255] of the IP address must not be assigned to any other equipment. These address numbers are reserved.

Rule3

The IP address must correlate to a network number. If network numbers are different between the equipment, they cannot establish communications each other. In this case, the router is placed in the networks to make the routing.

Q What is the MAC address assigned to the Network Board?

A The MAC address is indicated on the printed board as the below.

